

UCF 306 ASAHI

Ball bearing units

TYPE: Housing units, Four-bolt flanged housing units, Cast iron housing, Radial insert ball bearing with grub screws in inner ring, Type UCF (ASAHI)

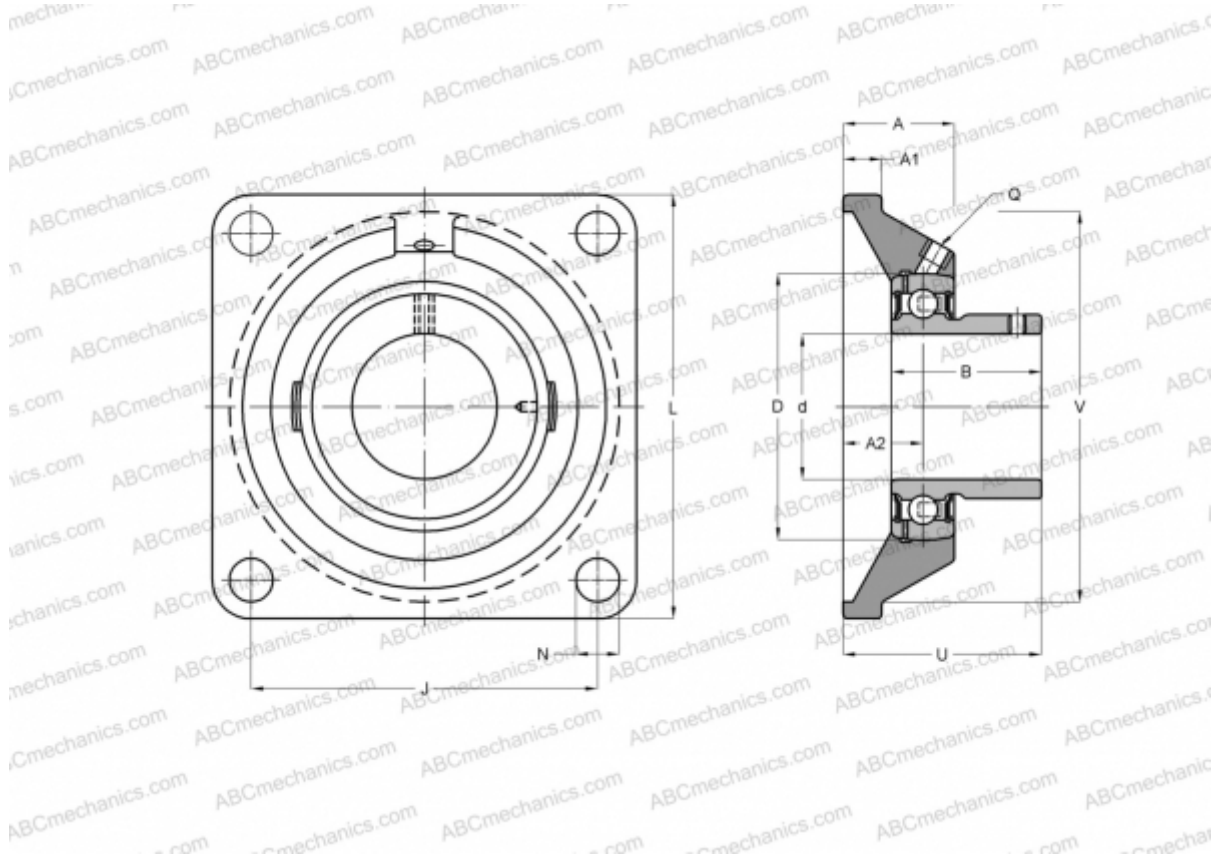

Technical specification

DIMENSIONS, MM

d	30,000
D	72,000
B	43,000
L	125,000
A	32,000
J	95,000
A1	15,000
A2	18,000
N	16,000
U	44,000

MANUFACTURER

[ASAHI](#)

WEIGHT, KG

1,700

Bearing	UC 306
Housing	F 306