

UCF 310 ASAHI

Ball bearing units

TYPE: Housing units, Four-bolt flanged housing units, Cast iron housing, Radial insert ball bearing with grub screws in inner ring, Type UCF (ASAHI)

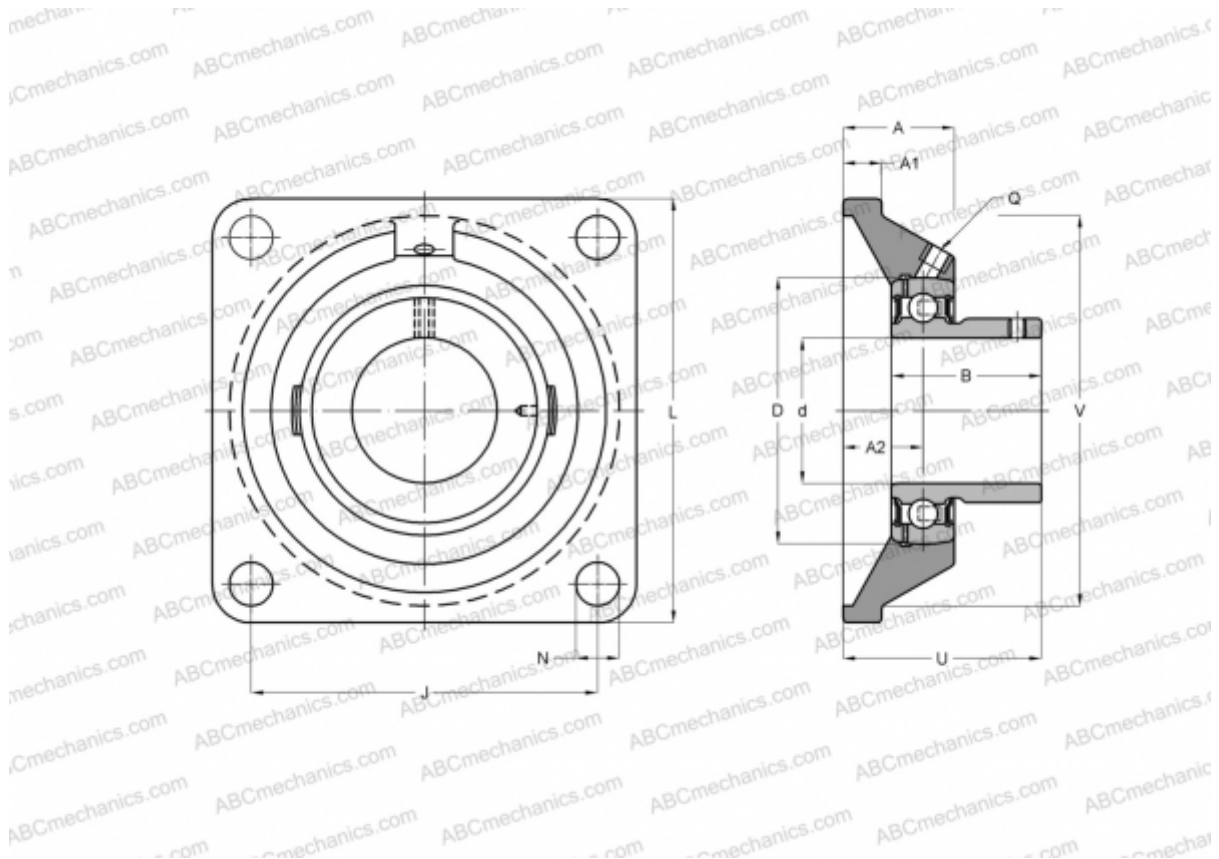

Technical specification

DIMENSIONS, MM

d	50,000
D	110,000
B	61,000
L	175,000
A	48,000
J	132,000
A1	19,000
A2	28,000
N	23,000
U	67,000

MANUFACTURER

[ASAHI](#)

WEIGHT, KG

4,700

Bearing	UC 310
Housing	F 310