

## UCF 311 ASAHI

Ball bearing units

TYPE: Housing units, Four-bolt flanged housing units, Cast iron housing, Radial insert ball bearing with grub screws in inner ring, Type UCF (ASAHI)

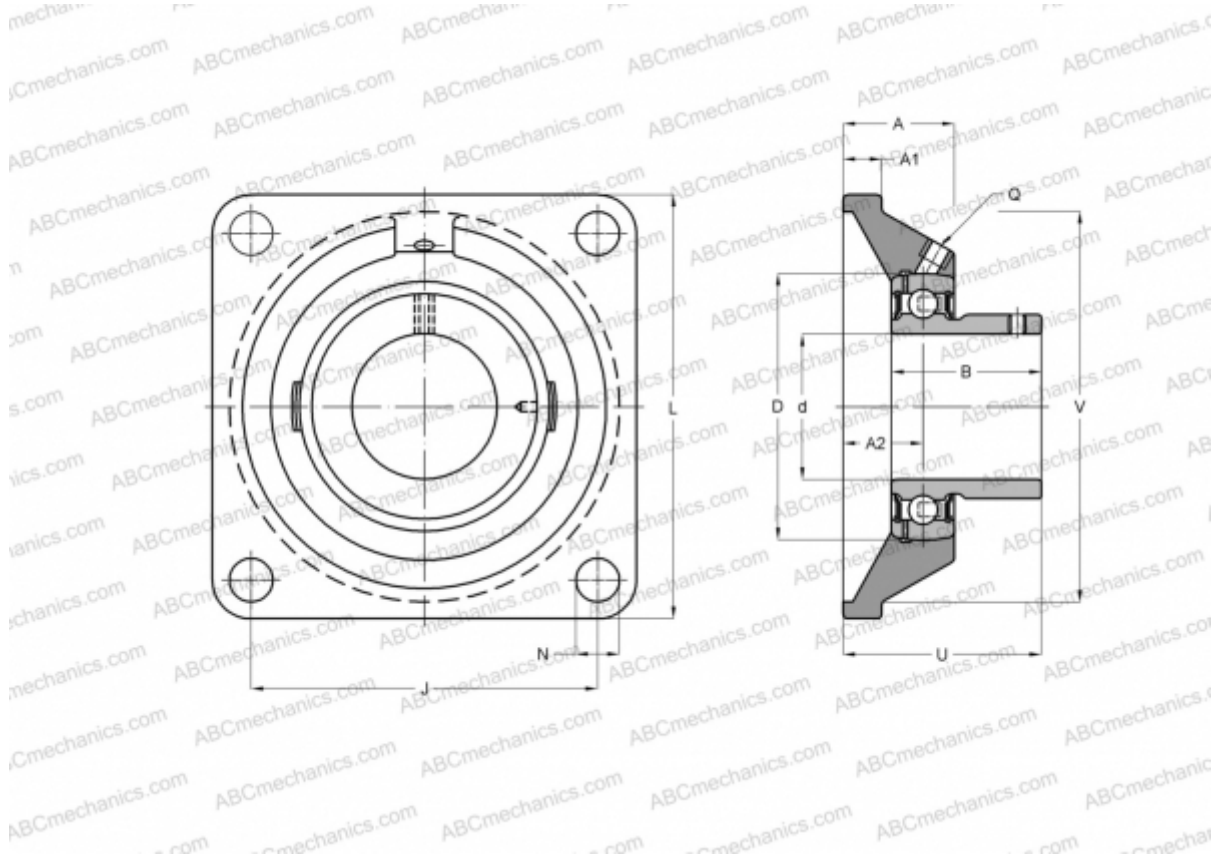

### Technical specification

#### DIMENSIONS, MM

d	55,000
D	120,000
B	66,000
L	185,000
A	52,000
J	140,000
A1	20,000
A2	30,000
N	23,000
U	71,000

#### MANUFACTURER

[ASAHI](#)

#### WEIGHT, KG

5,700

Bearing	UC 311
Housing	F 311