

UCF 312 ASAHI

Ball bearing units

TYPE: Housing units, Four-bolt flanged housing units, Cast iron housing, Radial insert ball bearing with grub screws in inner ring, Type UCF (ASAHI)

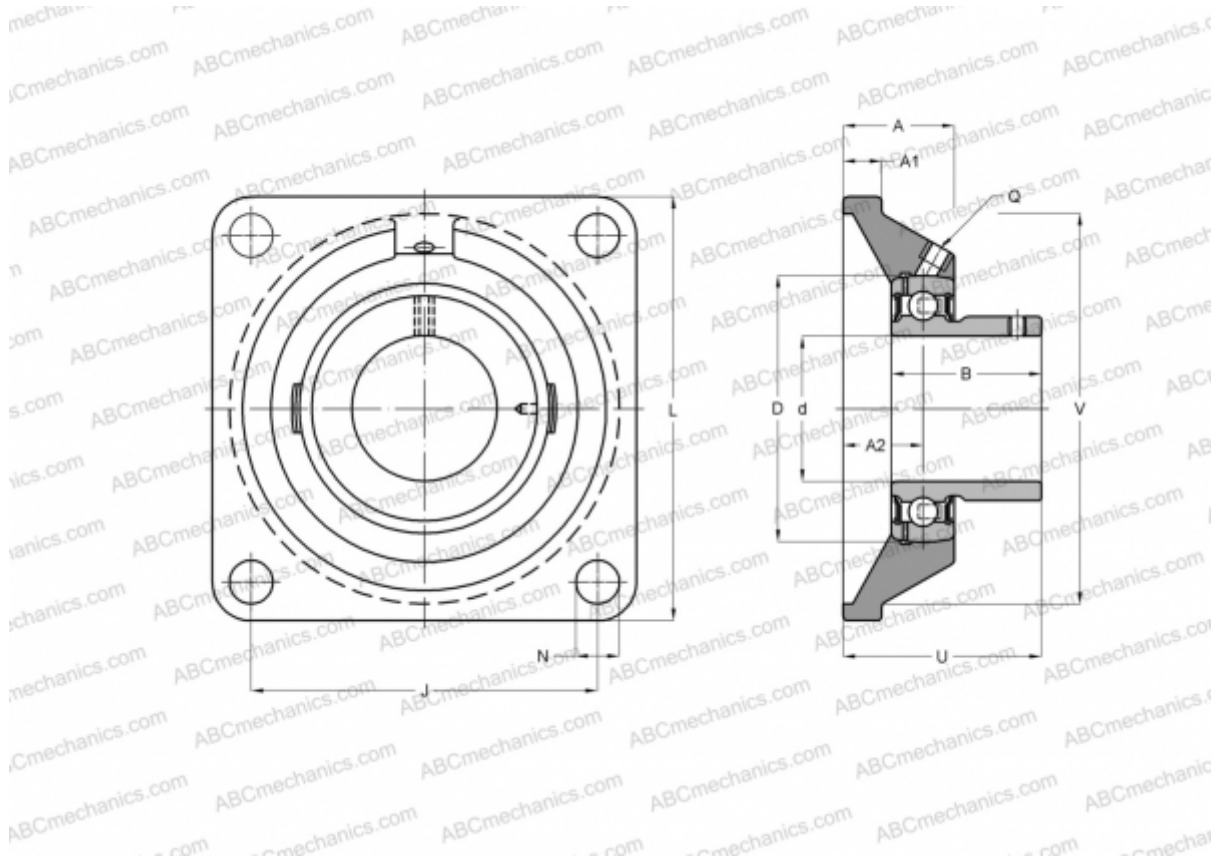

Technical specification

DIMENSIONS, MM

d	60,000
D	130,000
B	71,000
L	195,000
A	56,000
J	150,000
A1	22,000
A2	33,000
N	23,000
U	78,000

MANUFACTURER

[ASAHI](#)

WEIGHT, KG

6,800

Bearing	UC 312
Housing	F 312