

UCF 314 ASAHI

Ball bearing units

TYPE: Housing units, Four-bolt flanged housing units, Cast iron housing, Radial insert ball bearing with grub screws in inner ring, Type UCF (ASAHI)

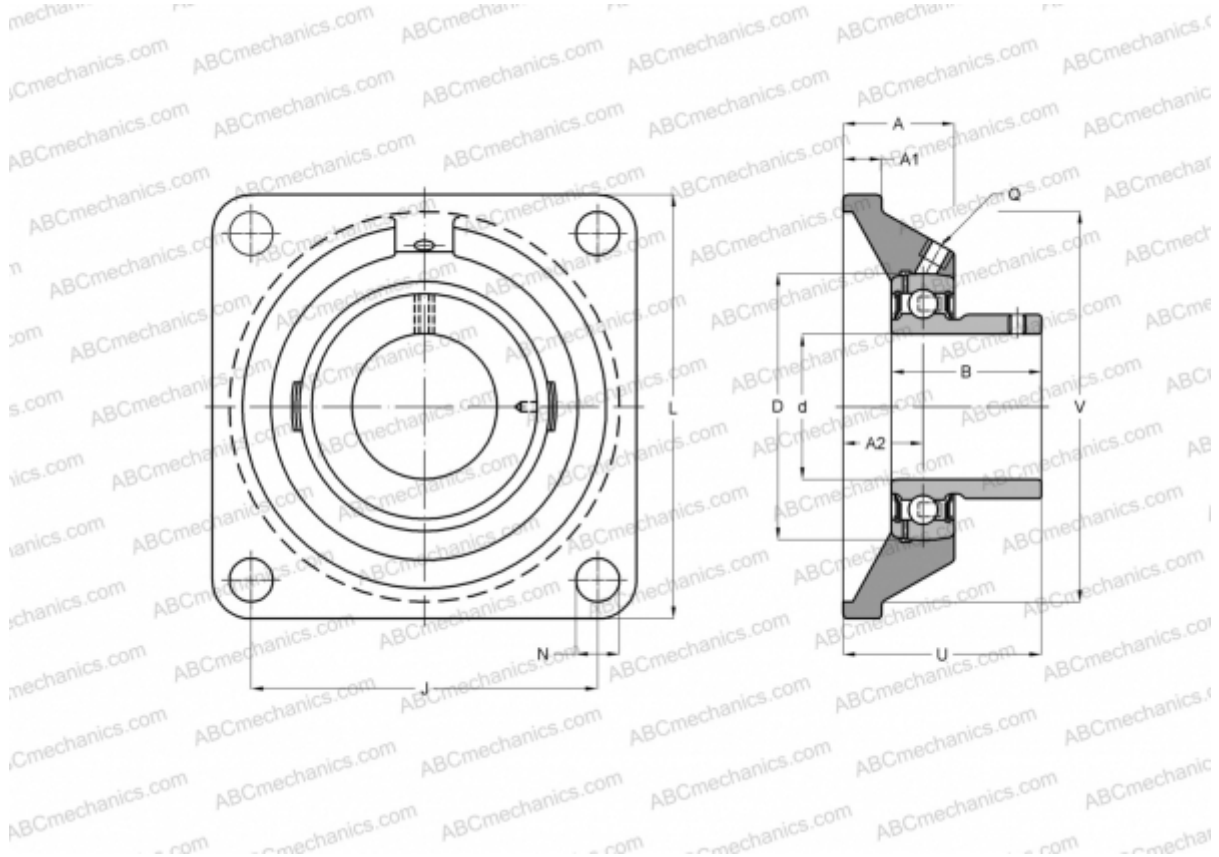

Technical specification

DIMENSIONS, MM

d	70,000
D	150,000
B	78,000
L	226,000
A	61,000
J	178,000
A1	25,000
A2	36,000
N	25,000
U	81,000

MANUFACTURER

[ASAHI](#)

WEIGHT, KG

9,600

Bearing	UC 314
Housing	F 314