

UCF 315 ASAHI

Ball bearing units

TYPE: Housing units, Four-bolt flanged housing units, Cast iron housing, Radial insert ball bearing with grub screws in inner ring, Type UCF (ASAHI)

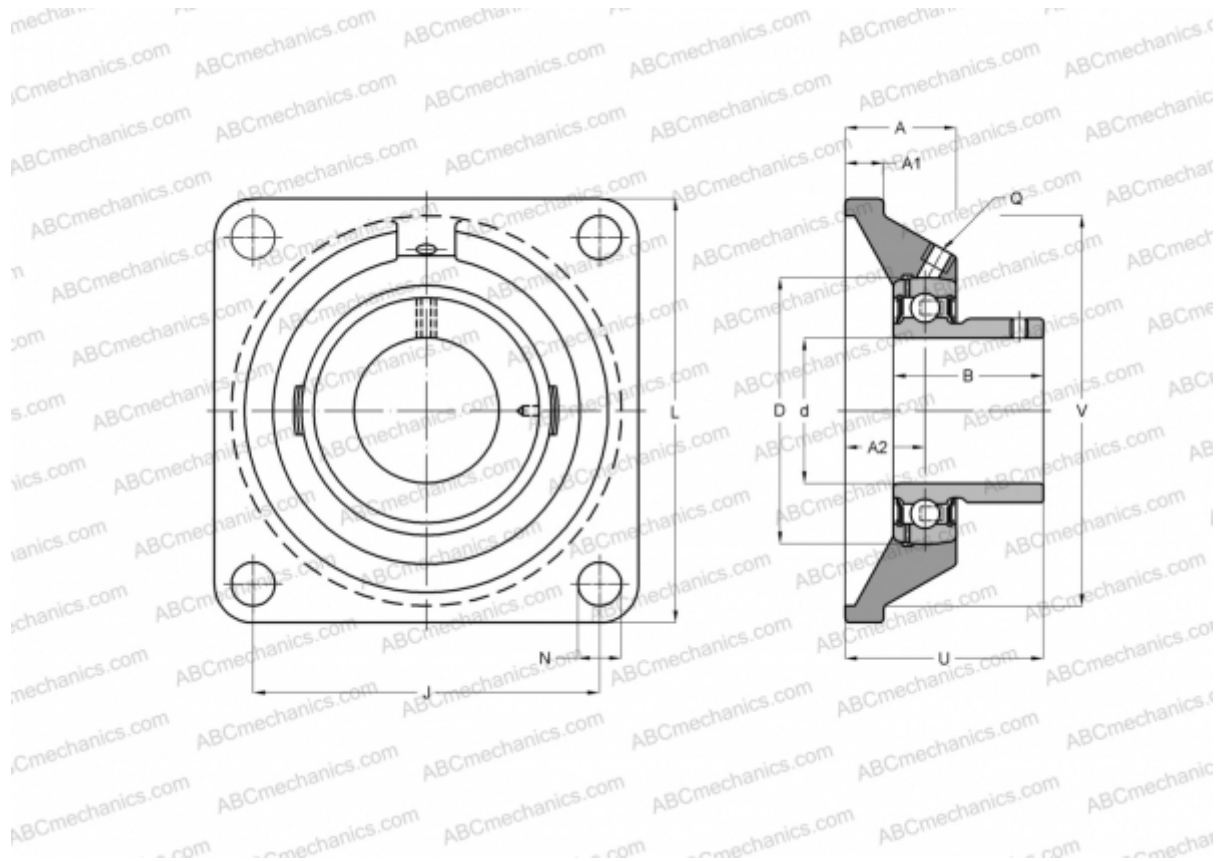

Technical specification

DIMENSIONS, MM

d	75,000
D	160,000
B	82,000
L	236,000
A	66,000
J	184,000
A1	25,000
A2	39,000
N	25,000
U	89,000

MANUFACTURER

[ASAHI](#)

WEIGHT, KG

11,700

Bearing	UC 315
Housing	F 315