

UCF 316 ASAHI

Ball bearing units

TYPE: Housing units, Four-bolt flanged housing units, Cast iron housing, Radial insert ball bearing with grub screws in inner ring, Type UCF (ASAHI)

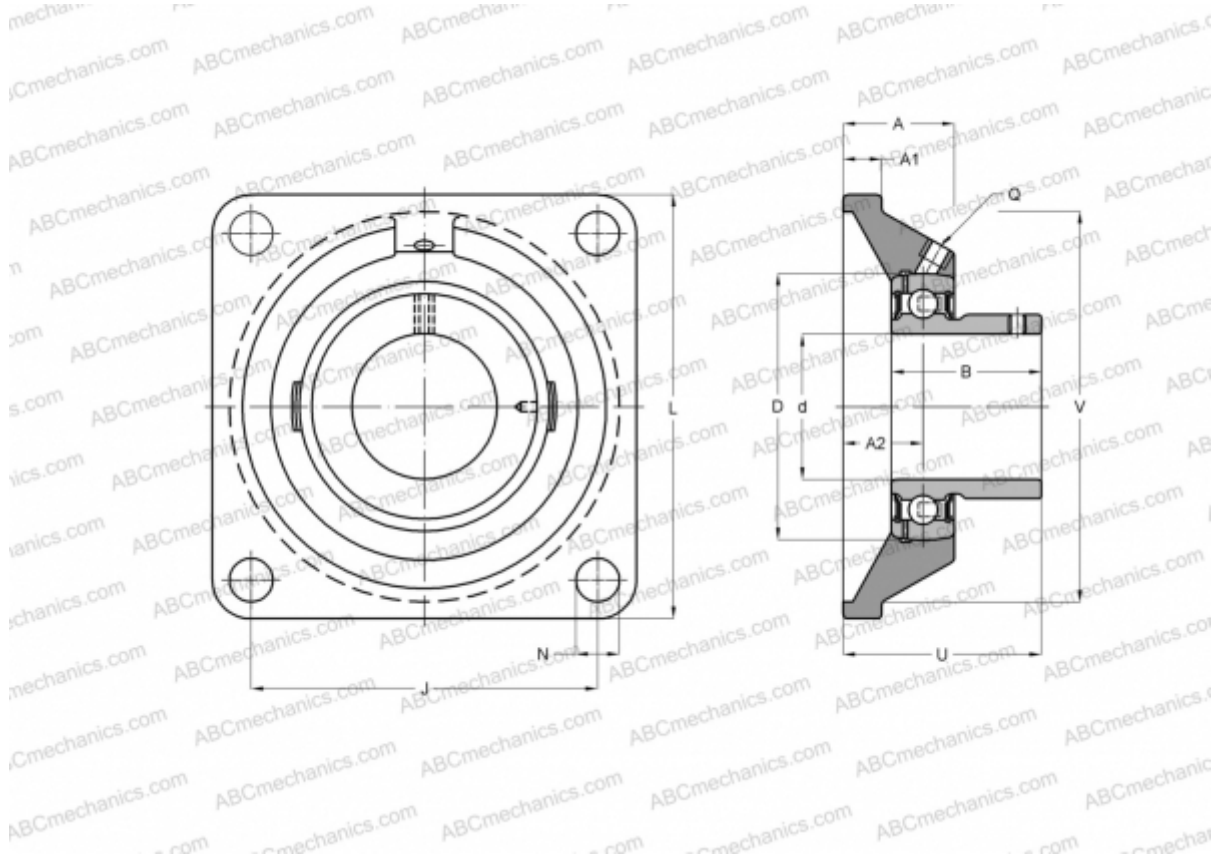

Technical specification

DIMENSIONS, MM

d	80,000
D	170,000
B	86,000
L	250,000
A	68,000
J	196,000
A1	27,000
A2	38,000
N	31,000
U	90,000

MANUFACTURER

[ASAHI](#)

WEIGHT, KG

13,700

Bearing	UC 316
Housing	F 316