

## UCF 317 ASAHI

Ball bearing units

TYPE: Housing units, Four-bolt flanged housing units, Cast iron housing, Radial insert ball bearing with grub screws in inner ring, Type UCF (ASAHI)

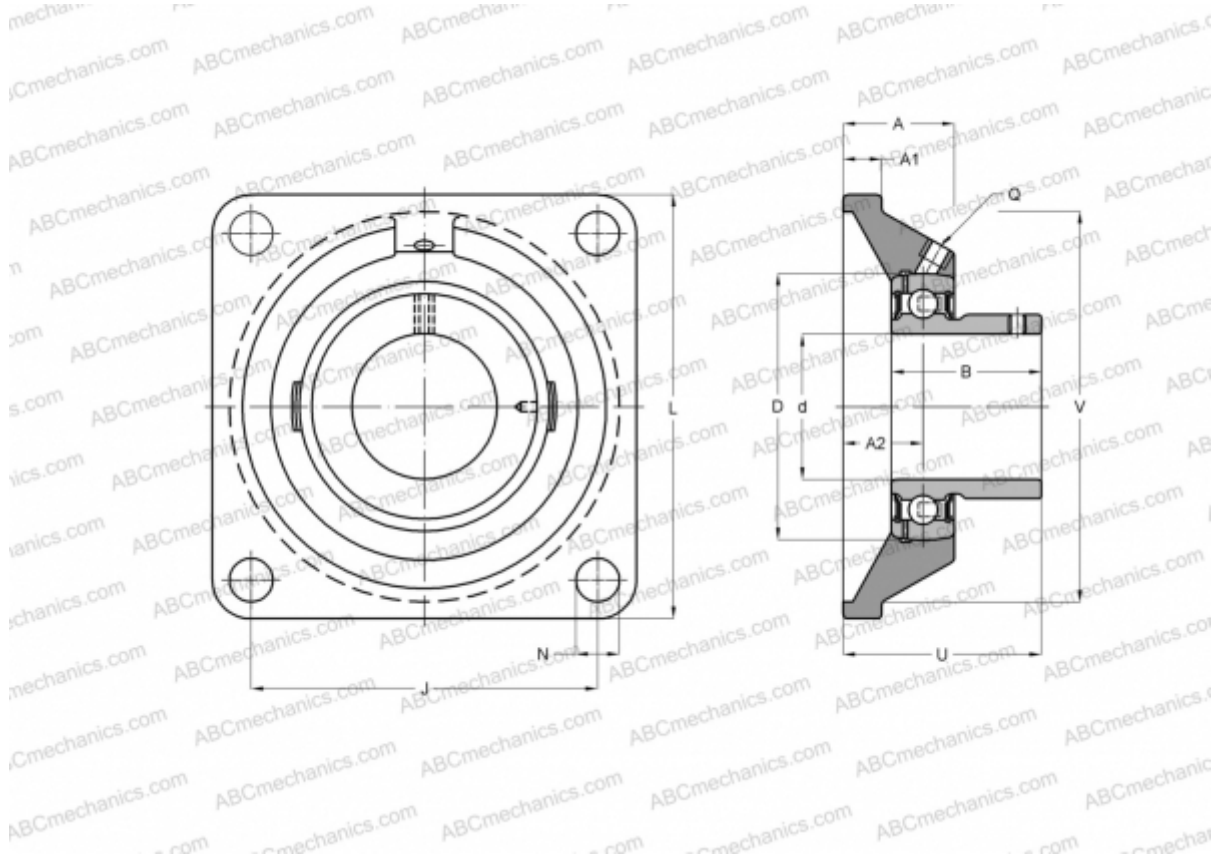

### Technical specification

#### DIMENSIONS, MM

d	85,000
D	180,000
B	96,000
L	260,000
A	74,000
J	204,000
A1	27,000
A2	44,000
N	31,000
U	100,000

#### MANUFACTURER

[ASAHI](#)

#### WEIGHT, KG

15,200

Bearing	UC 317
Housing	F 317