

UCF 318 ASAHI

Ball bearing units

TYPE: Housing units, Four-bolt flanged housing units, Cast iron housing, Radial insert ball bearing with grub screws in inner ring, Type UCF (ASAHI)

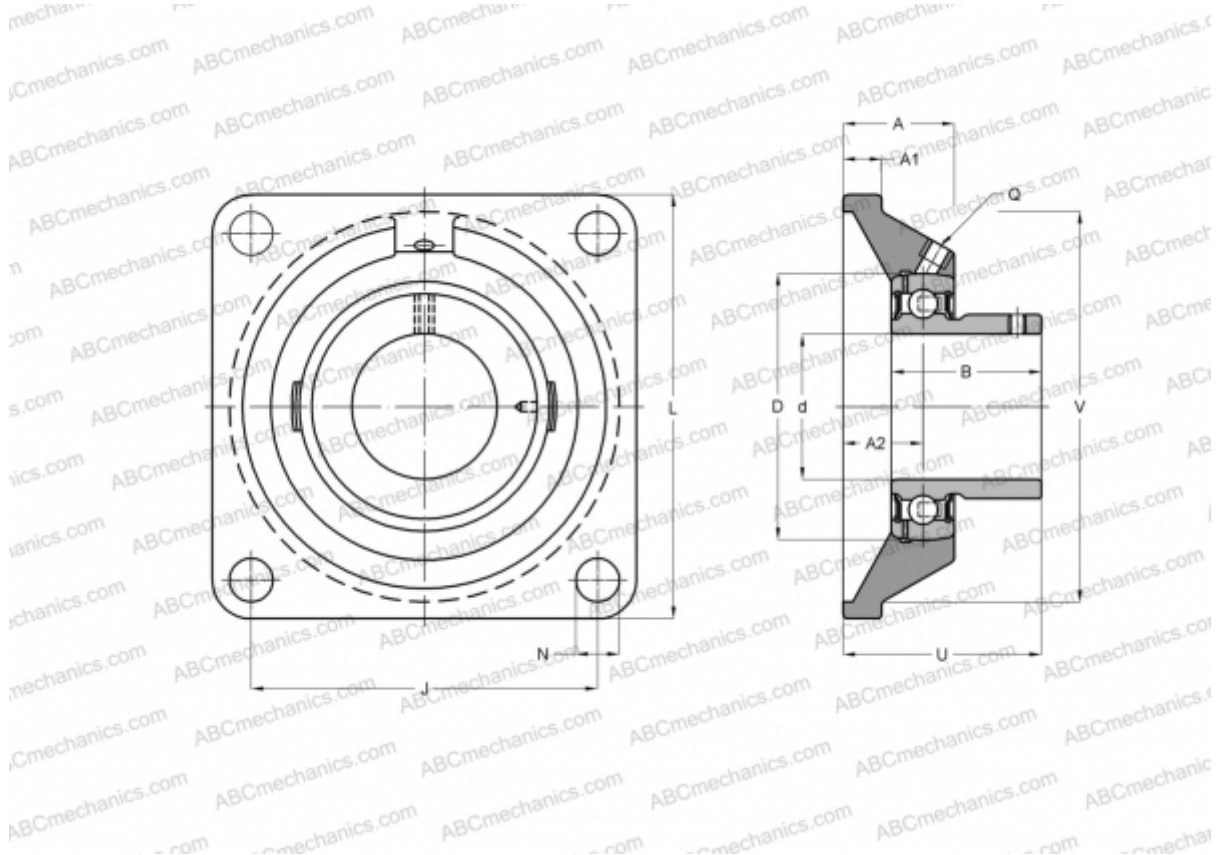

Technical specification

DIMENSIONS, MM

d	90,000
D	190,000
B	96,000
L	280,000
A	76,000
J	216,000
A1	30,000
A2	44,000
N	35,000
U	100,000

MANUFACTURER

[ASAHI](#)

WEIGHT, KG

18,800

Bearing	UC 318
Housing	F 318