

UCF 319 ASAHI

Ball bearing units

TYPE: Housing units, Four-bolt flanged housing units, Cast iron housing, Radial insert ball bearing with grub screws in inner ring, Type UCF (ASAHI)

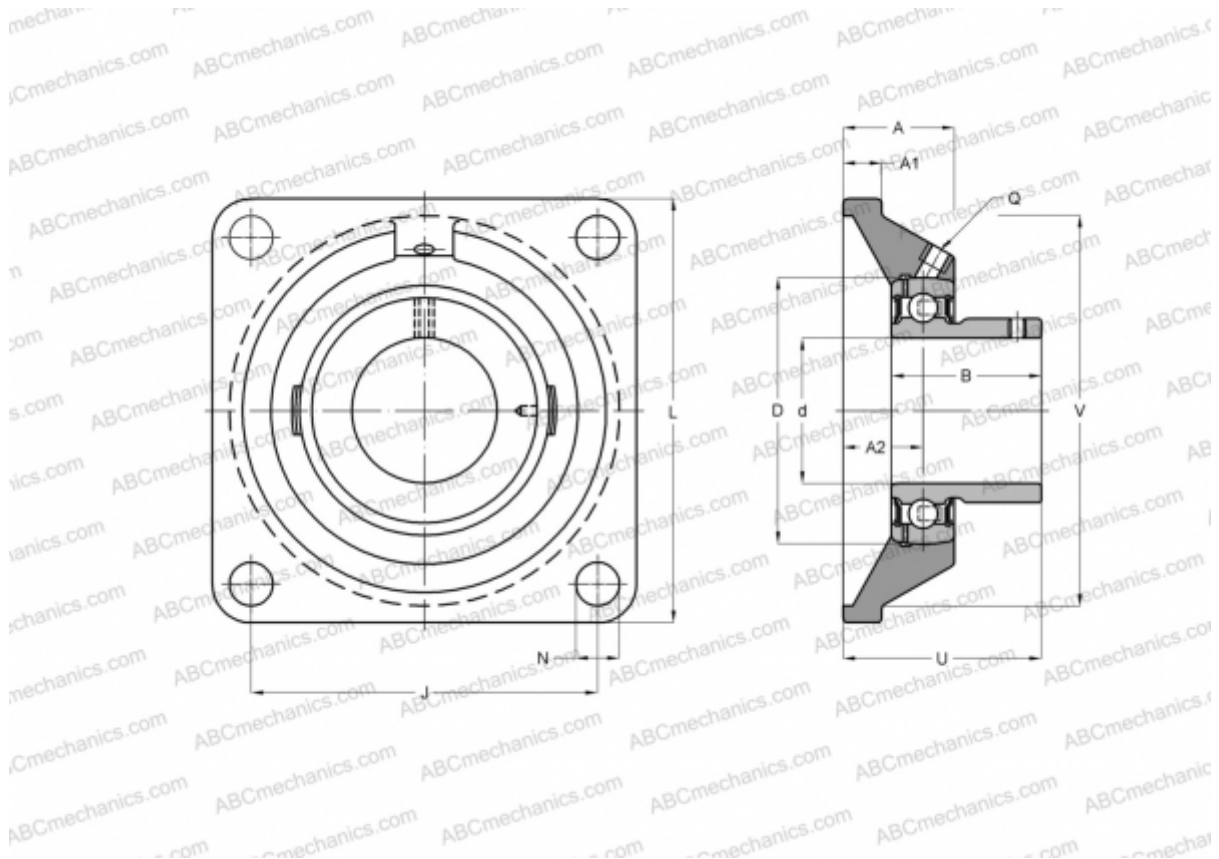

Technical specification

DIMENSIONS, MM

d	95,000
D	200,000
B	103,000
L	290,000
A	94,000
J	228,000
A1	30,000
A2	59,000
N	35,000
U	121,000

MANUFACTURER

[ASAHI](#)

WEIGHT, KG

20,700

Bearing	UC 319
Housing	F 319