

UCF 320 ASAHI

Ball bearing units

TYPE: Housing units, Four-bolt flanged housing units, Cast iron housing, Radial insert ball bearing with grub screws in inner ring, Type UCF (ASAHI)

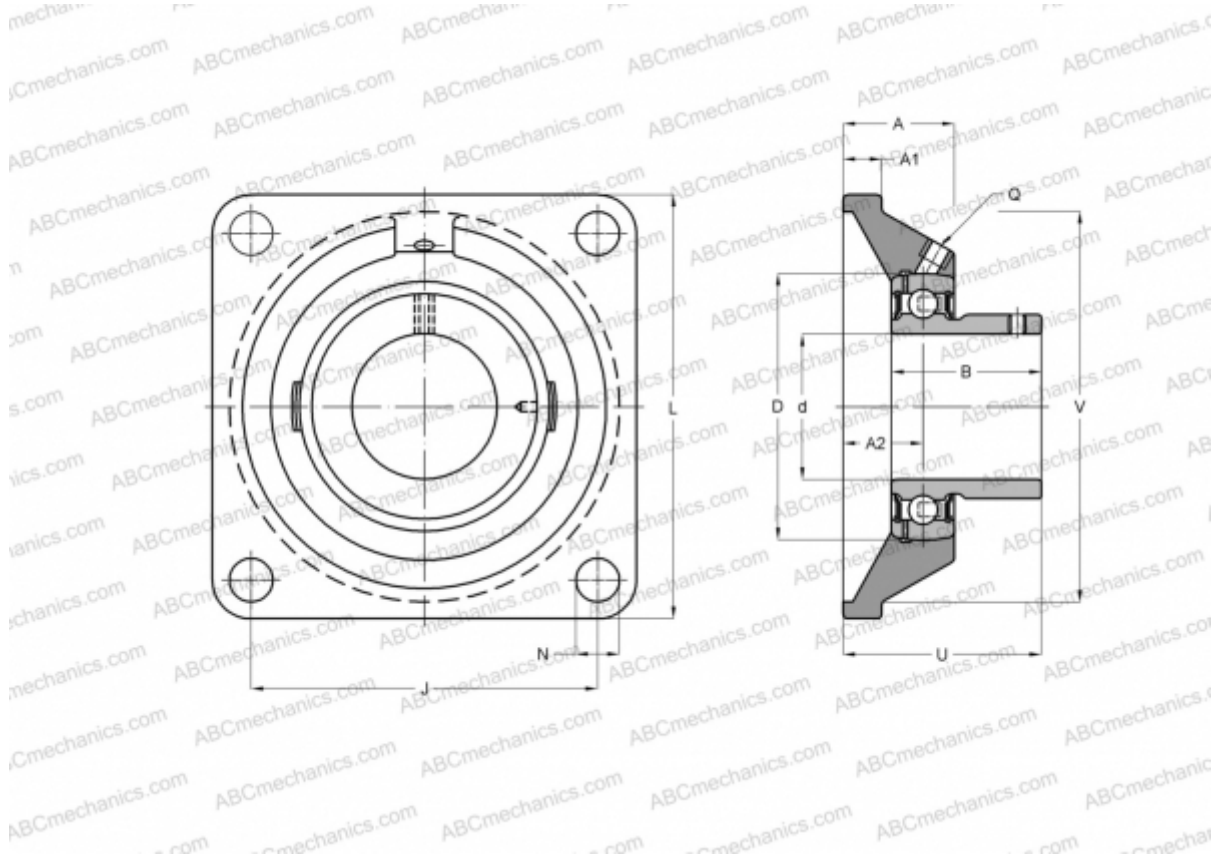

Technical specification

DIMENSIONS, MM

d	100,000
D	215,000
B	108,000
L	310,000
A	94,000
J	242,000
A1	32,000
A2	59,000
N	38,000
U	125,000

MANUFACTURER

[ASAHI](#)

WEIGHT, KG

24,800

Bearing	UC 320
Housing	F 320