

UCF 321 ASAHI

Ball bearing units

TYPE: Housing units, Four-bolt flanged housing units, Cast iron housing, Radial insert ball bearing with grub screws in inner ring, Type UCF (ASAHI)

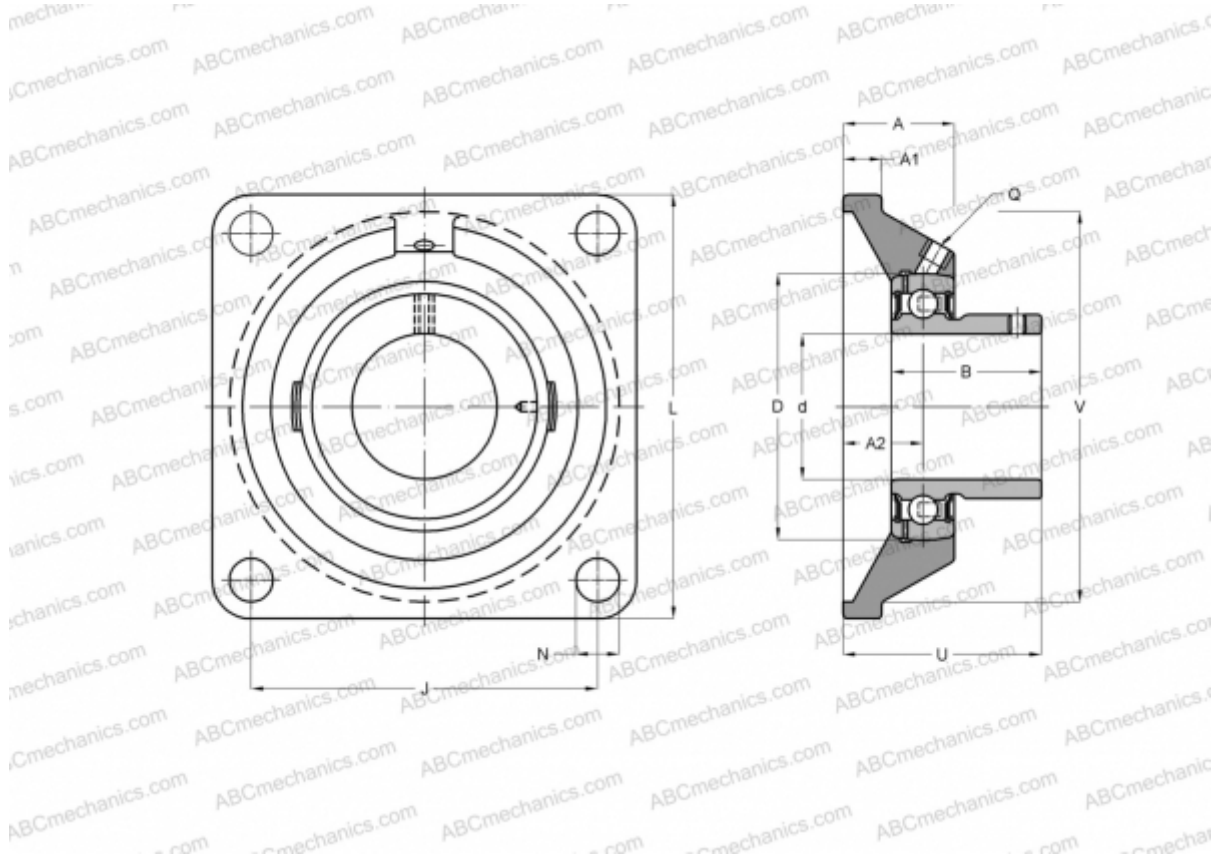

Technical specification

DIMENSIONS, MM

d	105,000
D	225,000
B	112,000
L	310,000
A	94,000
J	242,000
A1	32,000
A2	59,000
N	38,000
U	127,000

MANUFACTURER

[ASAHI](#)

WEIGHT, KG

25,600

Bearing	UC 321
Housing	F 321