

UCF X07 ASAHI

Ball bearing units

TYPE: Housing units, Four-bolt flanged housing units, Cast iron housing, Radial insert ball bearing with grub screws in inner ring, Type UCFX (ASAHI)

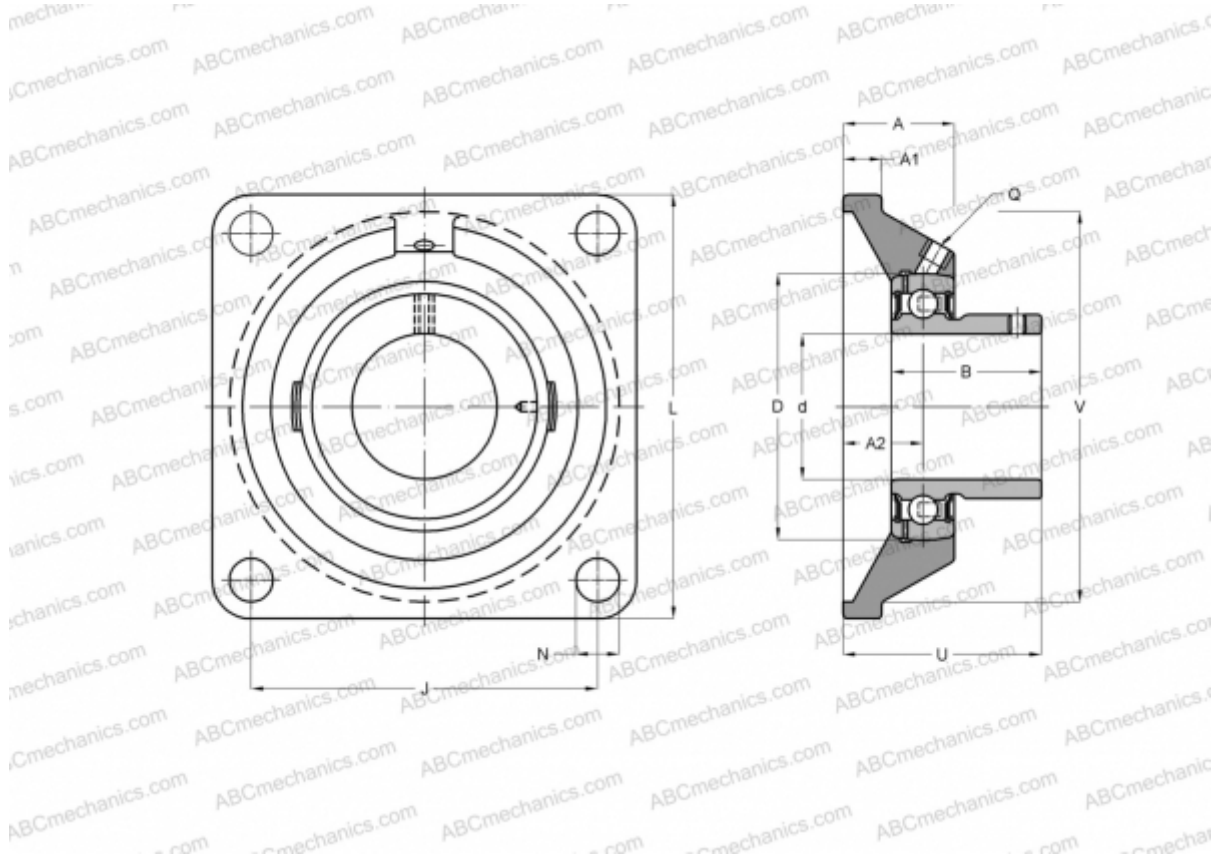

Technical specification

DIMENSIONS, MM

d	35,000
D	80,000
B	49,200
L	130,000
A	38,000
J	102,000
A1	14,000
A2	21,000
N	16,000
U	51,200

MANUFACTURER

[ASAHI](#)

WEIGHT, KG

1,800

Bearing	UC X07
Housing	F X07