

UCF X08 ASAHI

Ball bearing units

TYPE: Housing units, Four-bolt flanged housing units, Cast iron housing, Radial insert ball bearing with grub screws in inner ring, Type UCFX (ASAHI)

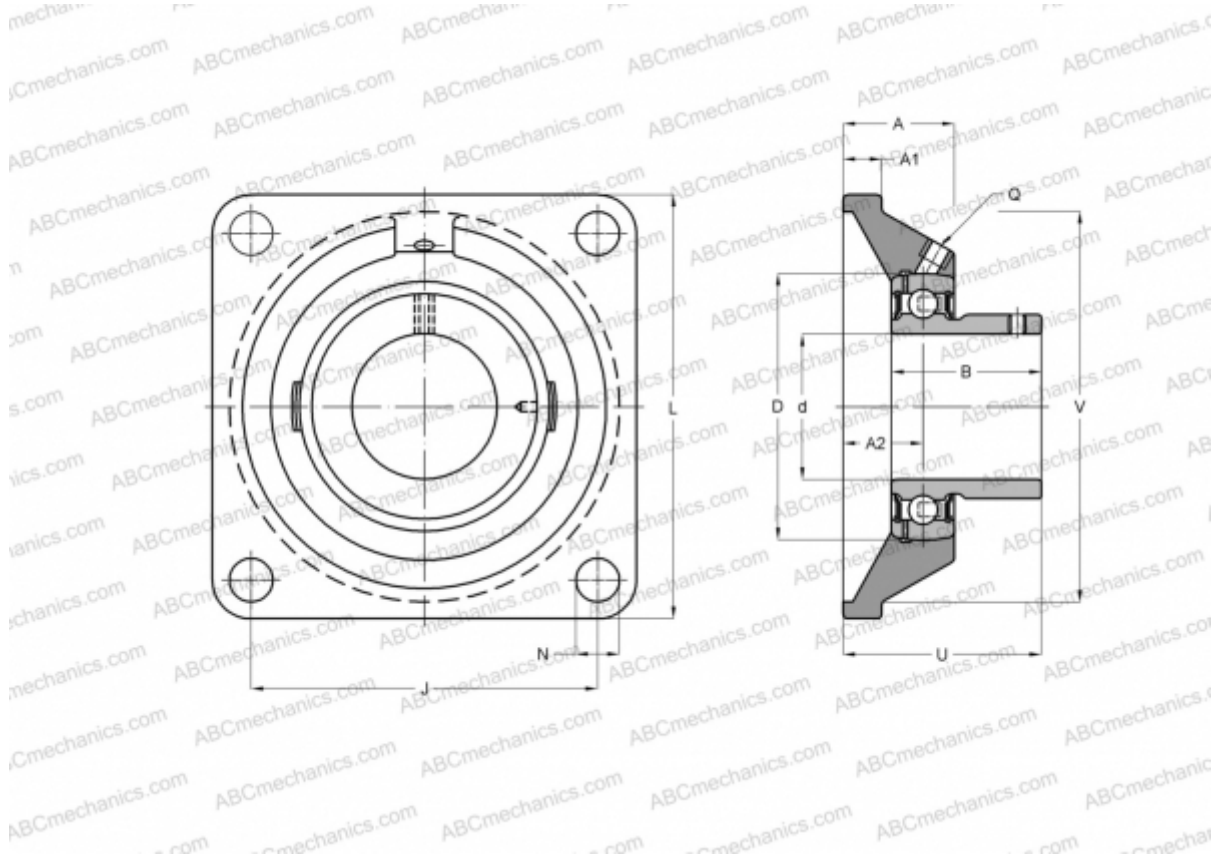

Technical specification

DIMENSIONS, MM

d	40,000
D	85,000
B	49,200
L	137,000
A	40,000
J	105,000
A1	14,000
A2	22,000
N	19,000
U	52,200

MANUFACTURER

[ASAHI](#)

WEIGHT, KG

1,800

Bearing	UC X08
Housing	F X08