

UCF X09 ASAHI

Ball bearing units

TYPE: Housing units, Four-bolt flanged housing units, Cast iron housing, Radial insert ball bearing with grub screws in inner ring, Type UCFX (ASAHI)

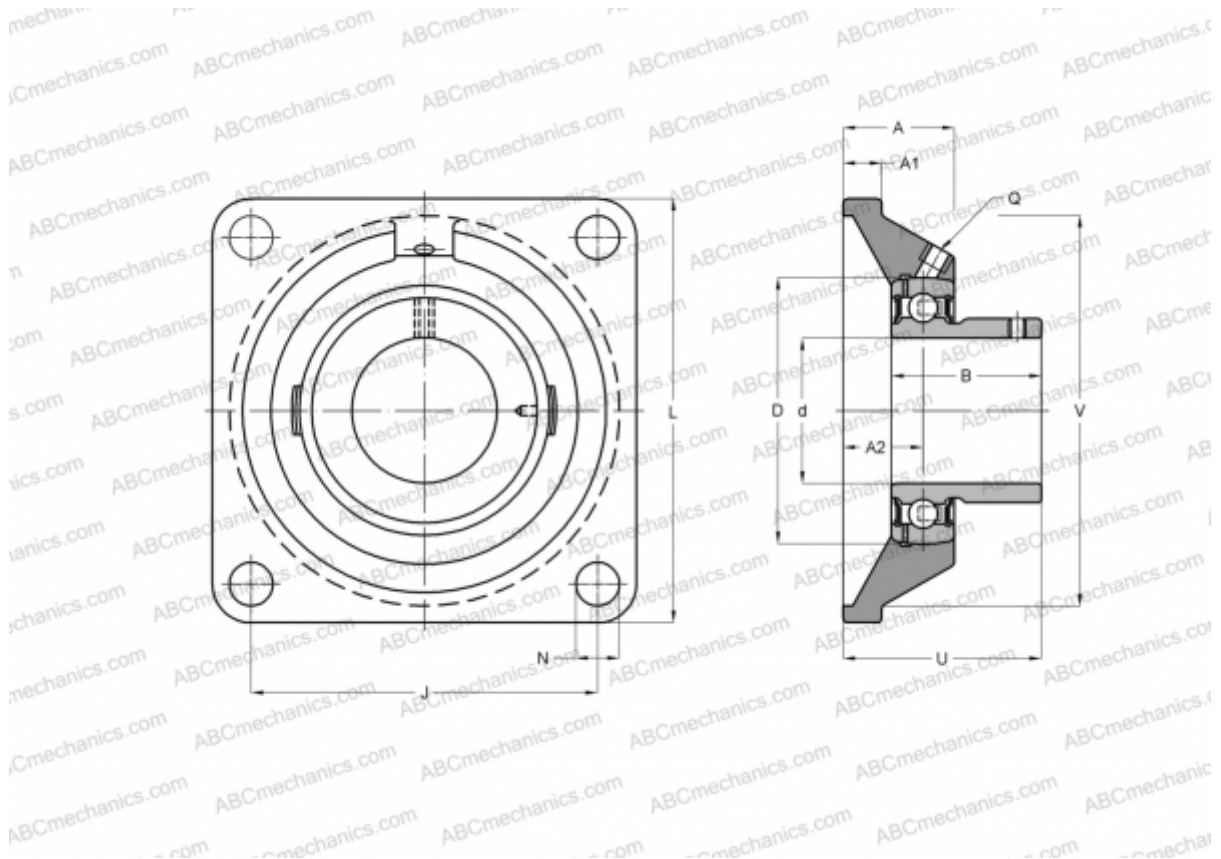

Technical specification

DIMENSIONS, MM

d	45,000
D	90,000
B	51,600
L	143,000
A	40,000
J	111,000
A1	14,000
A2	23,000
N	19,000
U	55,600

MANUFACTURER

[ASAHI](#)

WEIGHT, KG

2,400

Bearing	UC X09
Housing	F X09