

## UCF X10 ASAHI

Ball bearing units

TYPE: Housing units, Four-bolt flanged housing units, Cast iron housing, Radial insert ball bearing with grub screws in inner ring, Type UCFX (ASAHI)

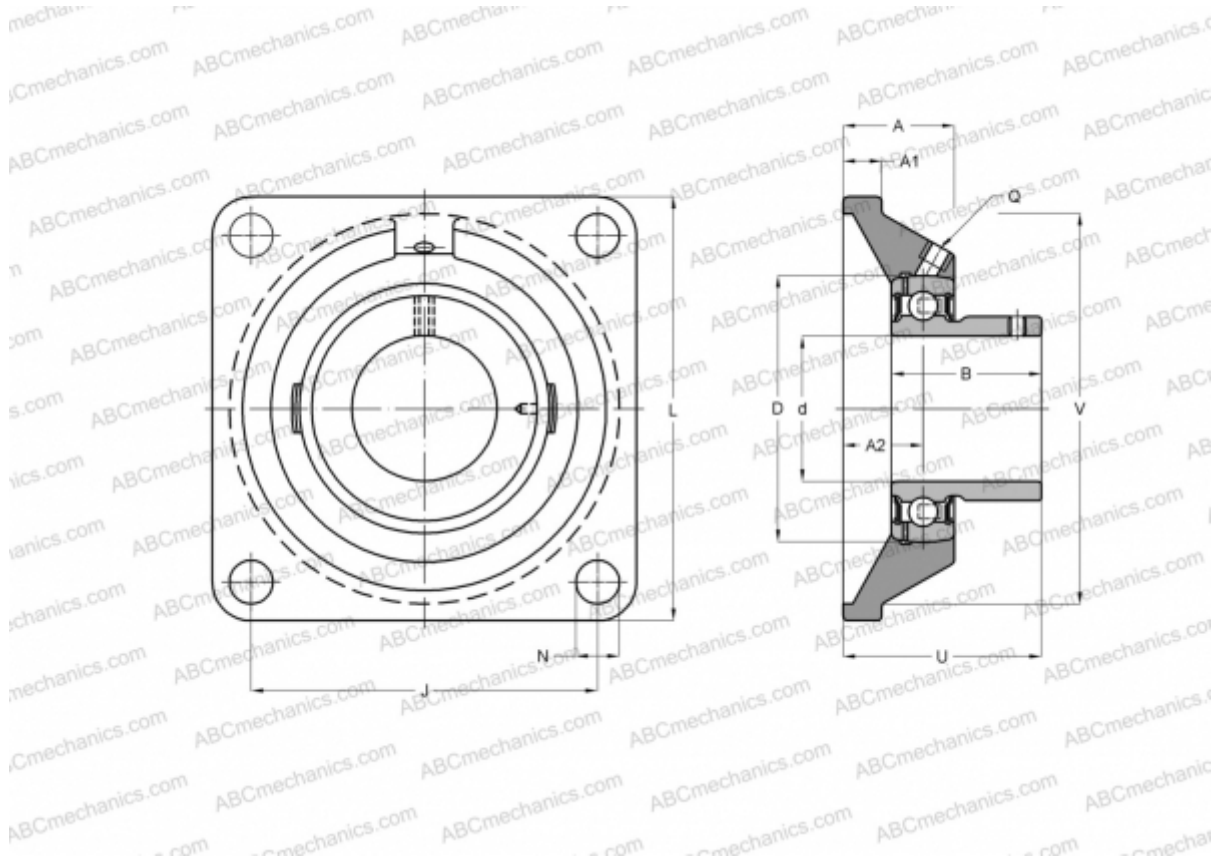

### Technical specification

#### DIMENSIONS, MM

d	50,000
D	100,000
B	55,600
L	162,000
A	44,000
J	130,000
A1	20,000
A2	26,000
N	19,000
U	59,400

#### MANUFACTURER

[ASAHI](#)

#### WEIGHT, KG

3,600

Bearing	UC X10
Housing	F X10