

UCF X11 ASAHI

Ball bearing units

TYPE: Housing units, Four-bolt flanged housing units, Cast iron housing, Radial insert ball bearing with grub screws in inner ring, Type UCFX (ASAHI)

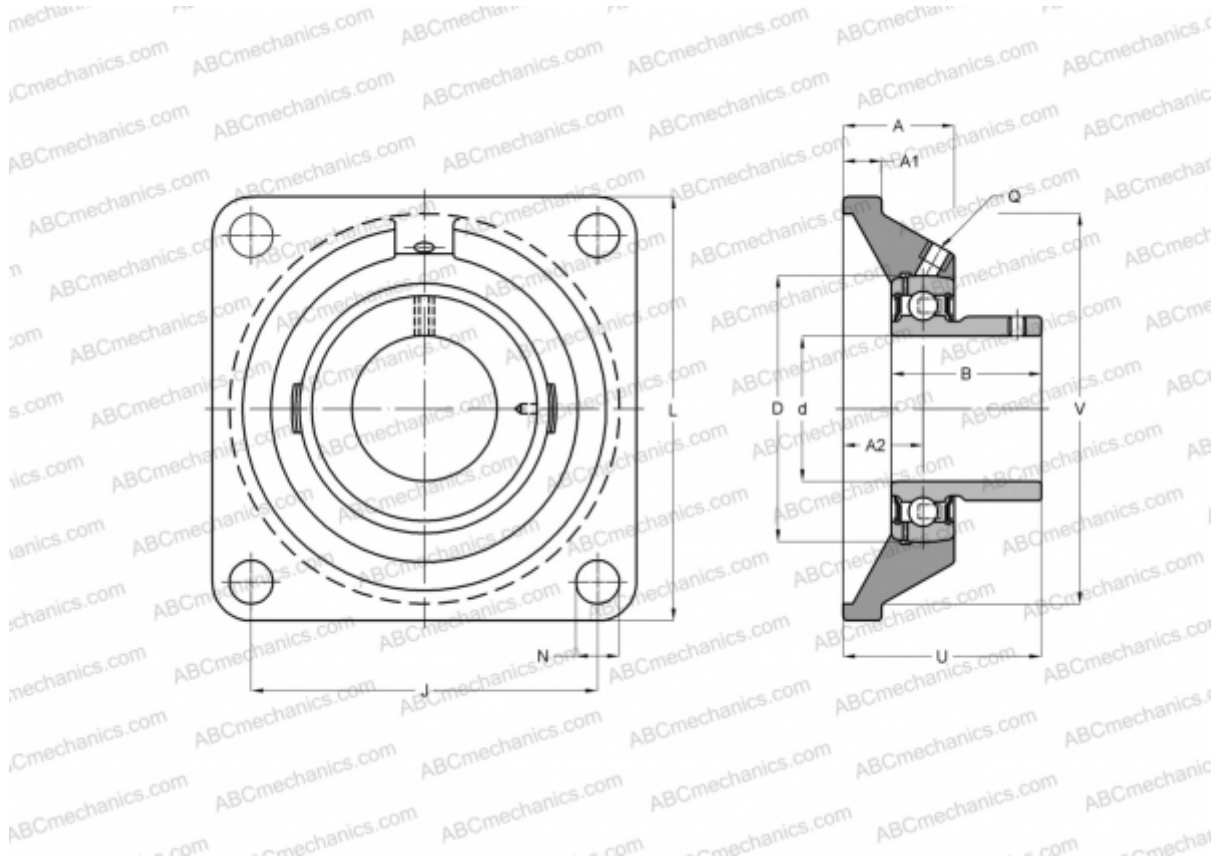

Technical specification

DIMENSIONS, MM

d	55,000
D	110,000
B	65,100
L	175,000
A	49,000
J	143,000
A1	20,000
A2	29,000
N	19,000
U	68,700

MANUFACTURER

[ASAHI](#)

WEIGHT, KG

4,500

Bearing	UC X11
Housing	F X11