

UCF X12 ASAHI

Ball bearing units

TYPE: Housing units, Four-bolt flanged housing units, Cast iron housing, Radial insert ball bearing with grub screws in inner ring, Type UCFX (ASAHI)

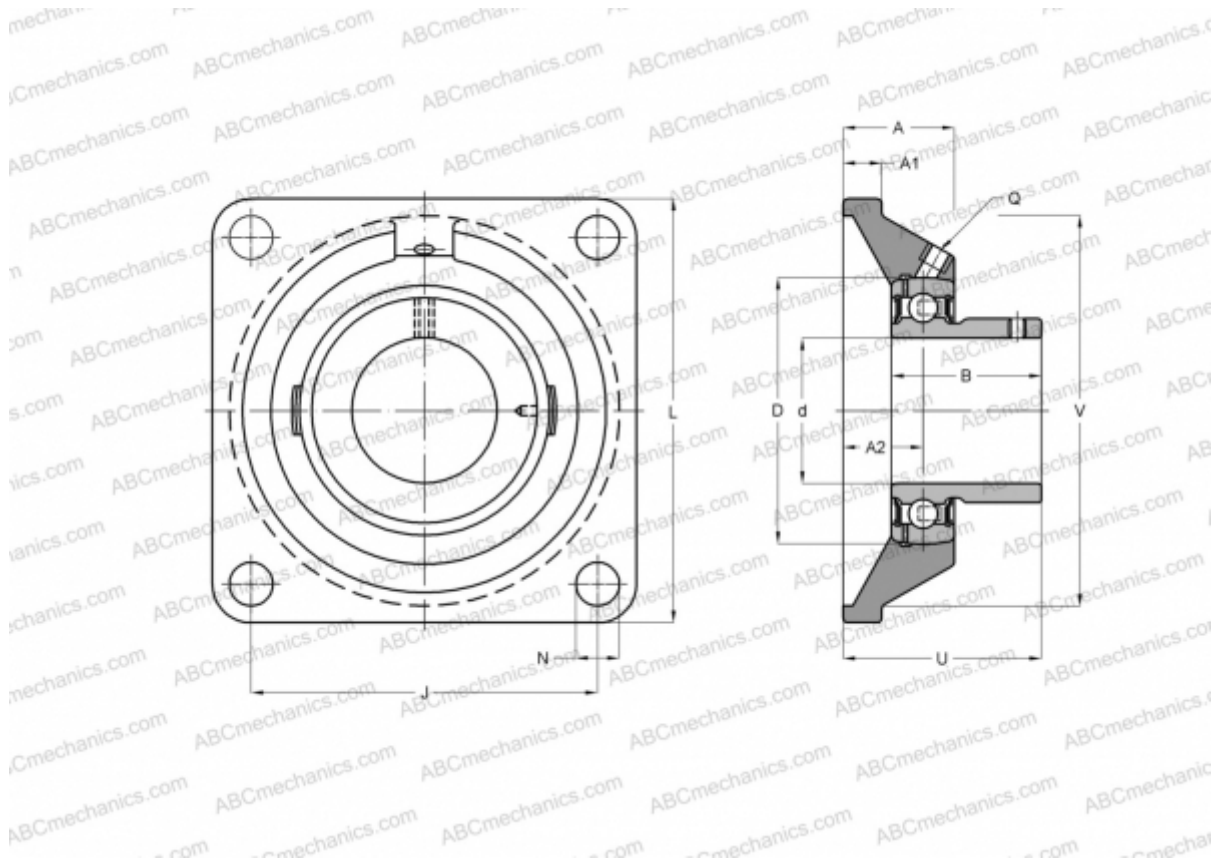

Technical specification

DIMENSIONS, MM

d	60,000
D	120,000
B	65,100
L	187,000
A	59,000
J	149,000
A1	21,000
A2	34,000
N	19,000
U	73,700

MANUFACTURER

[ASAHI](#)

WEIGHT, KG

5,300

Bearing	UC X12
Housing	F X12