

UCF X15 ASAHI

Ball bearing units

TYPE: Housing units, Four-bolt flanged housing units, Cast iron housing, Radial insert ball bearing with grub screws in inner ring, Type UCFX (ASAHI)

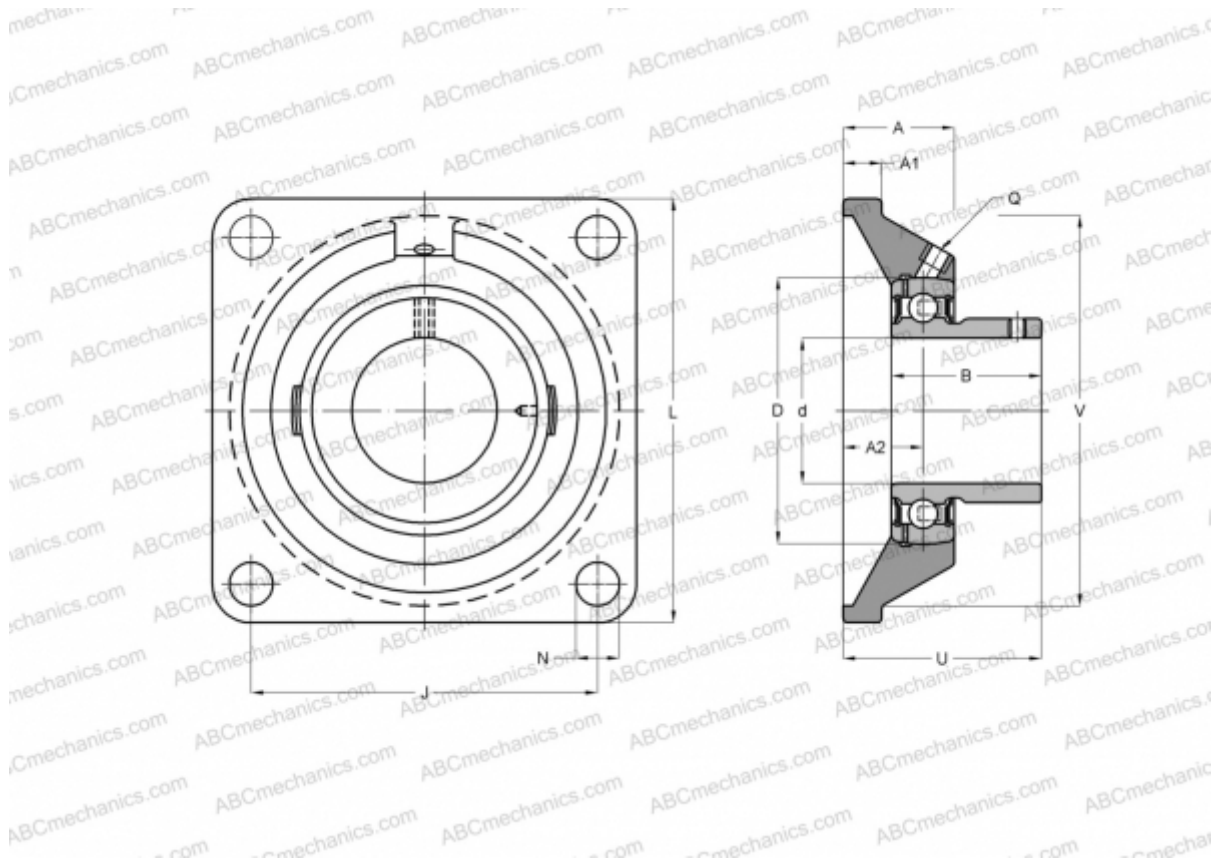

Technical specification

DIMENSIONS, MM

d	75,000
D	140,000
B	82,600
L	197,000
A	68,000
J	152,000
A1	24,000
A2	40,000
N	23,000
U	89,300

MANUFACTURER

[ASAHI](#)

WEIGHT, KG

7,700

Bearing	UC X15
Housing	F X15