

## UCF X17 ASAHI

Ball bearing units

TYPE: Housing units, Four-bolt flanged housing units, Cast iron housing, Radial insert ball bearing with grub screws in inner ring, Type UCFX (ASAHI)

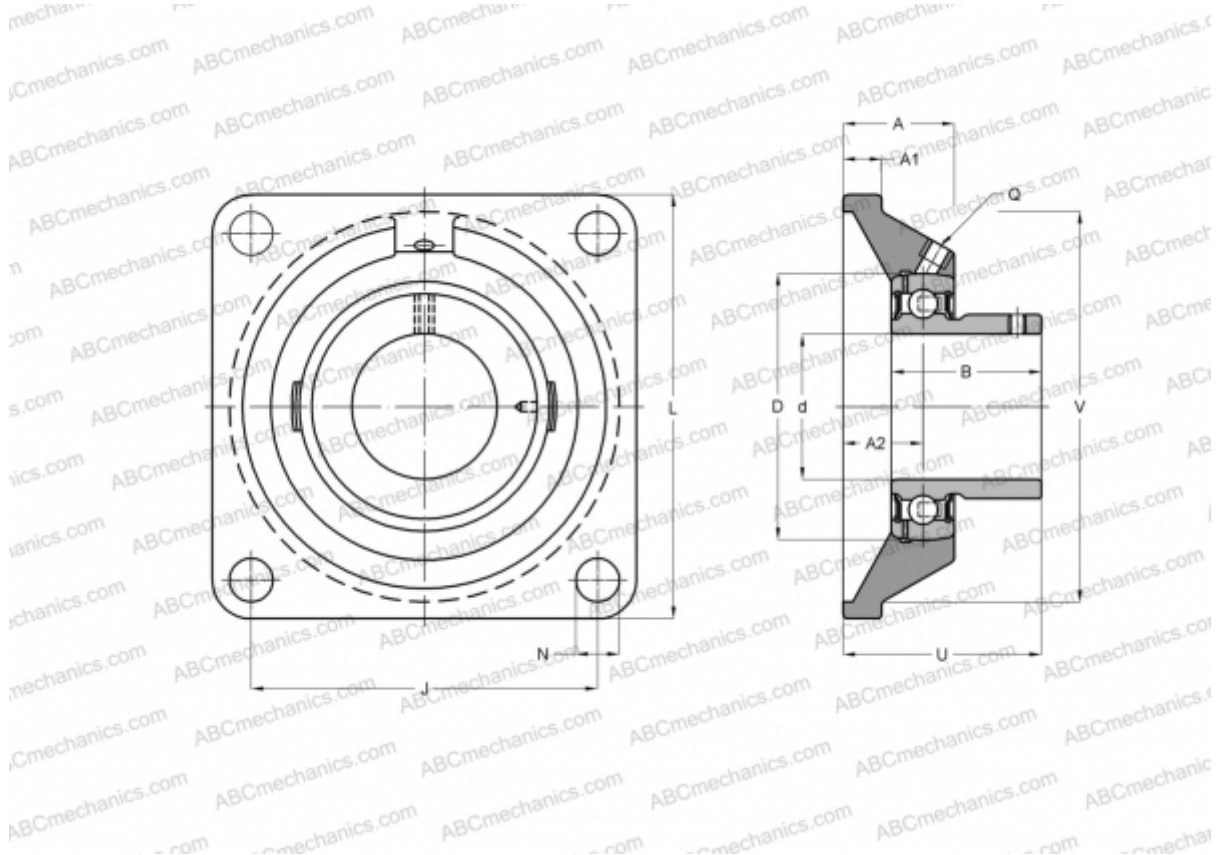

### Technical specification

#### DIMENSIONS, MM

d	85,000
D	160,000
B	96,000
L	214,000
A	70,000
J	171,000
A1	24,000
A2	40,000
N	23,000
U	96,300

#### MANUFACTURER

[ASAHI](#)

#### WEIGHT, KG

10,200

Bearing	UC X17
Housing	F X17