

UCLF 202 ASAHI

Ball bearing units

TYPE: Housing units, Four-bolt flanged housing units, Cast iron housing, Radial insert ball bearing with grub screws in inner ring, Type UCLF (ASAHI)

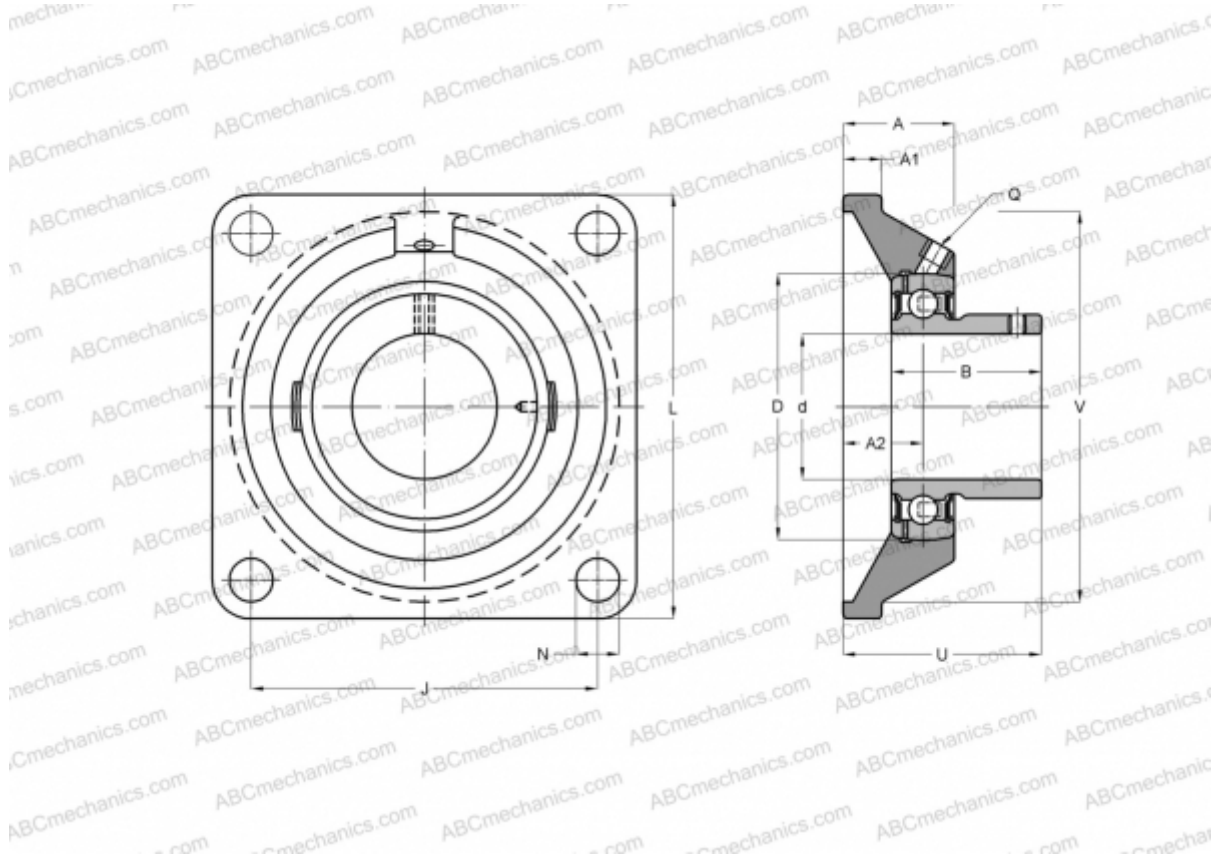

Technical specification

DIMENSIONS, MM

d	15,000
D	40,000
B	26,000
L	76,000
A	28,000
J	54,000
A1	10,000
A2	16,700
N	10,500
U	32,700

MANUFACTURER

[ASAHI](#)

WEIGHT, KG

0,510

Bearing	UCW 202
Housing	LF 203