

UCLF 204 ASAHI

Ball bearing units

TYPE: Housing units, Four-bolt flanged housing units, Cast iron housing, Radial insert ball bearing with grub screws in inner ring, Type UCLF (ASAHI)

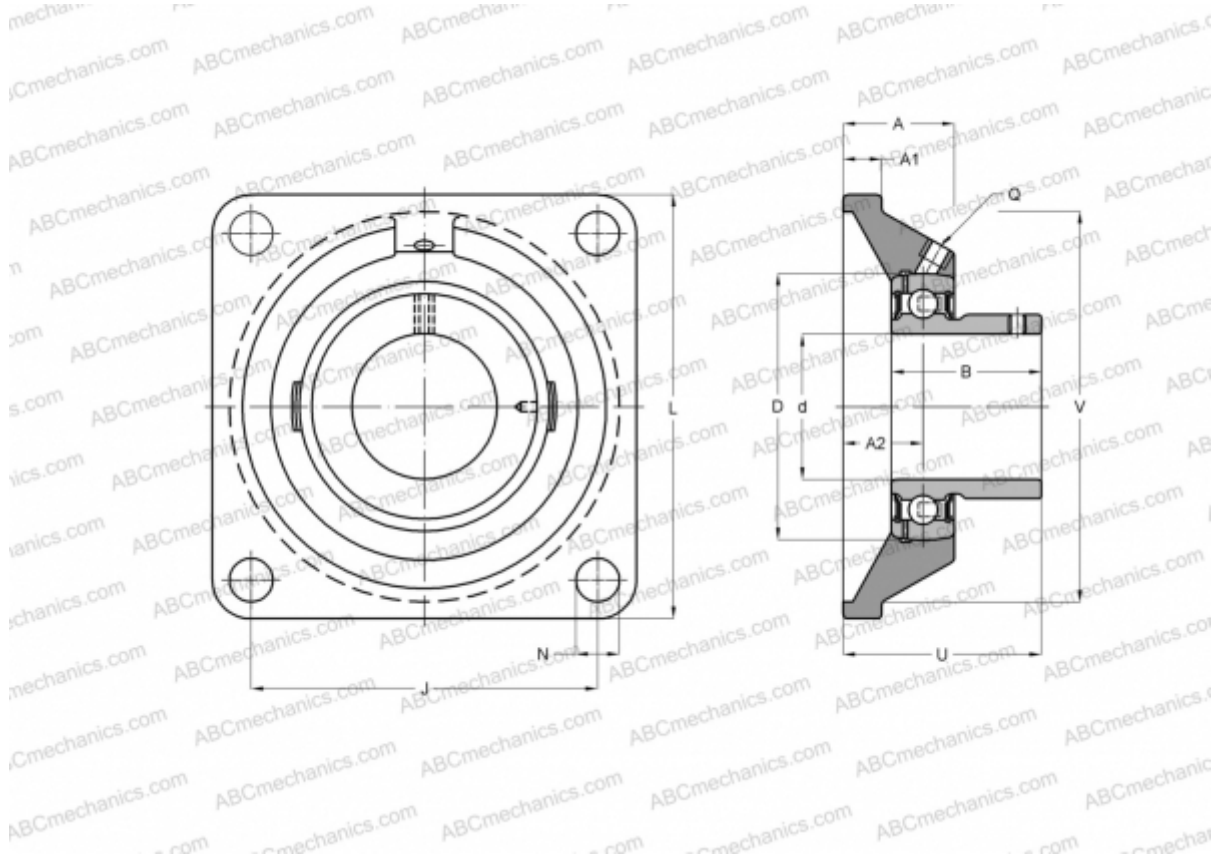

Technical specification

DIMENSIONS, MM

d	20,000
D	47,000
B	31,000
L	86,000
A	33,000
J	63,500
A1	10,000
A2	20,600
N	10,500
U	38,900

MANUFACTURER

[ASAHI](#)

WEIGHT, KG

0,680

Bearing	UC 204
Housing	LF 204