

UCLF 206 ASAHI

Ball bearing units

TYPE: Housing units, Four-bolt flanged housing units, Cast iron housing, Radial insert ball bearing with grub screws in inner ring, Type UCLF (ASAHI)

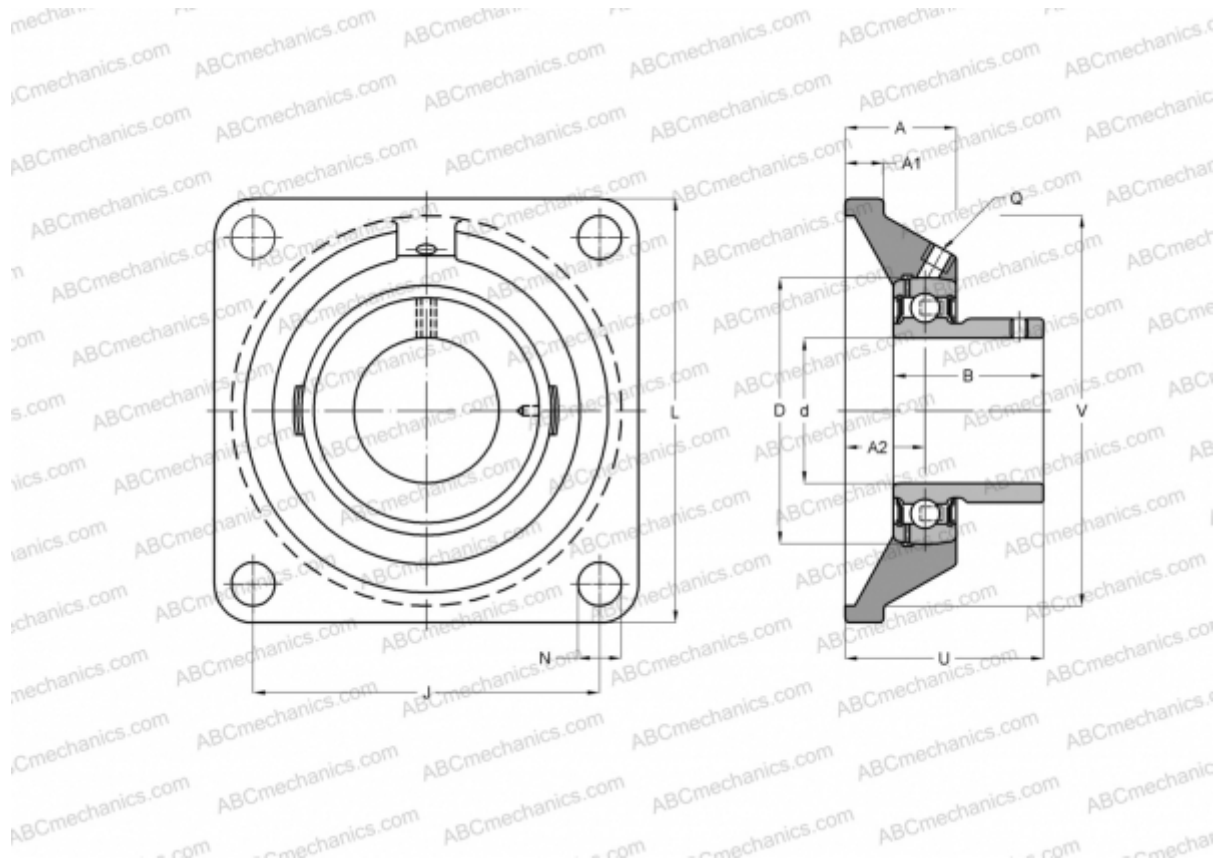

Technical specification

DIMENSIONS, MM

d	30,000
D	62,000
B	38,100
L	108,000
A	37,000
J	82,600
A1	13,000
A2	22,600
N	12,500
U	44,800

MANUFACTURER

[ASAHI](#)

WEIGHT, KG

1,200

Bearing	UC 206
Housing	LF 206