

UCLF 208 ASAHI

Ball bearing units

TYPE: Housing units, Four-bolt flanged housing units, Cast iron housing, Radial insert ball bearing with grub screws in inner ring, Type UCLF (ASAHI)

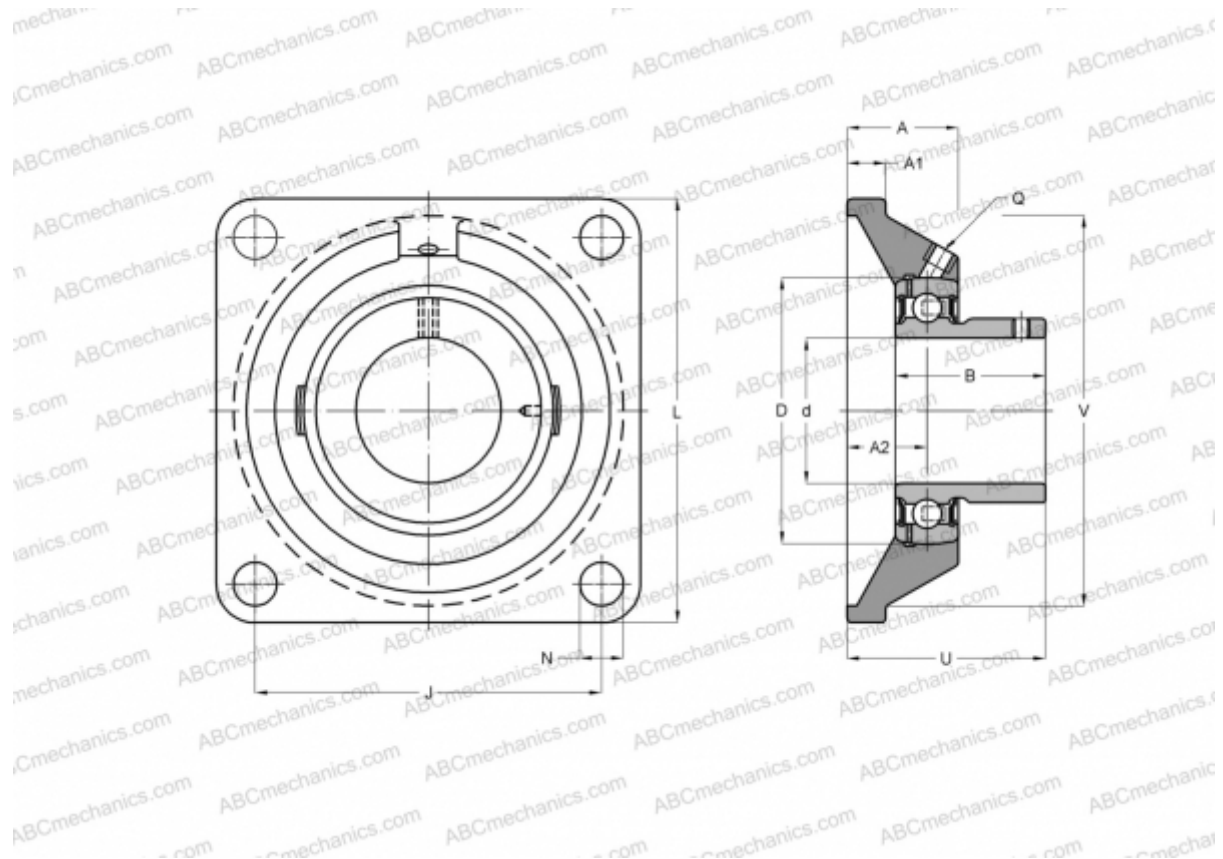

Technical specification

DIMENSIONS, MM

d	40,000
D	80,000
B	49,200
L	130,000
A	41,000
J	101,600
A1	16,000
A2	24,600
N	14,000
U	54,800

MANUFACTURER

[ASAHI](#)

WEIGHT, KG

2,100

Bearing	UC 208
Housing	LF 208