

UCFS 307 ASAHI

Ball bearing units

TYPE: Housing units, Four-bolt flanged housing units, Cast iron housing, Radial insert ball bearing with grub screws in inner ring, Type UCFS (ASAHI)

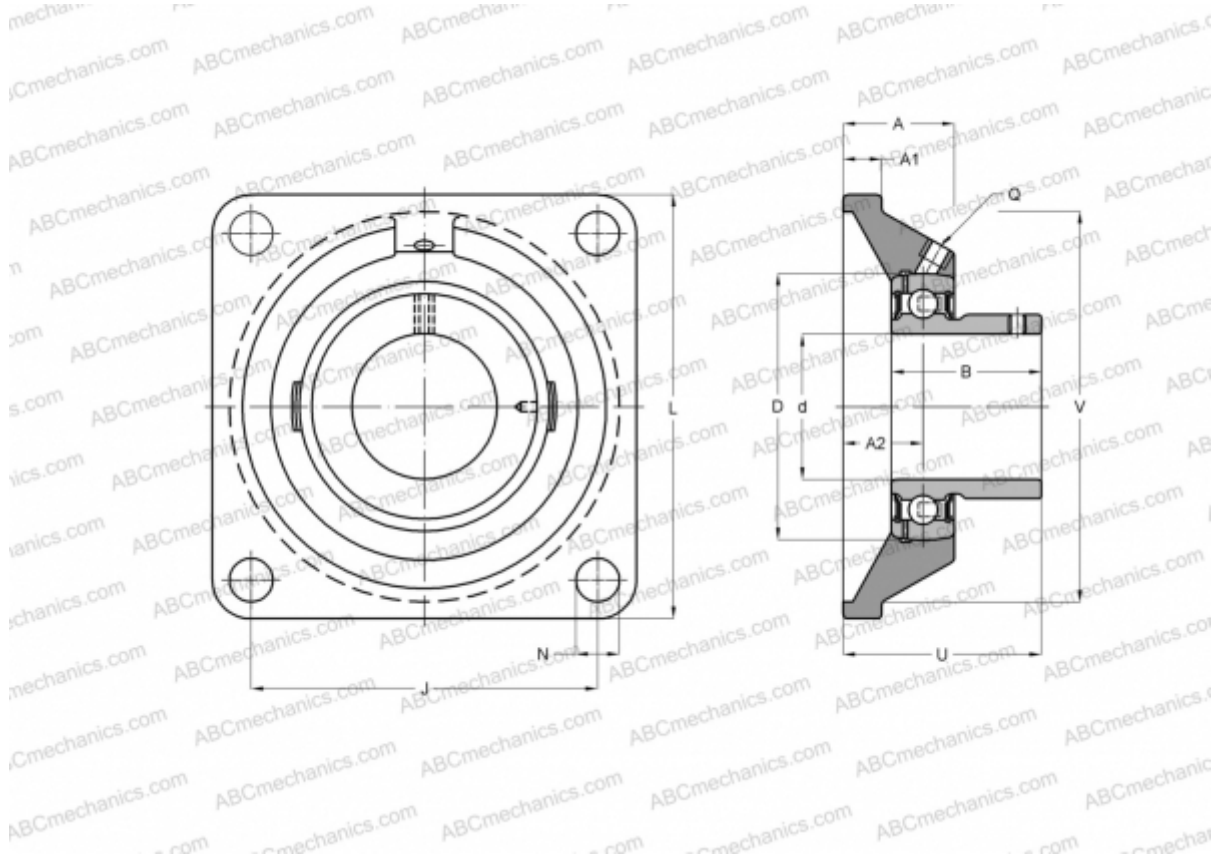

Technical specification

DIMENSIONS, MM

d	35,000
D	80,000
B	48,000
L	135,000
A	27,000
J	100,000
A1	16,000
N	19,000
U	40,000
V	100,000

MANUFACTURER

[ASAHI](#)

WEIGHT, KG

2,400

Bearing	UC 307
Housing	FS 307