

UCFS 313 ASAHI

Ball bearing units

TYPE: Housing units, Four-bolt flanged housing units, Cast iron housing, Radial insert ball bearing with grub screws in inner ring, Type UCFS (ASAHI)

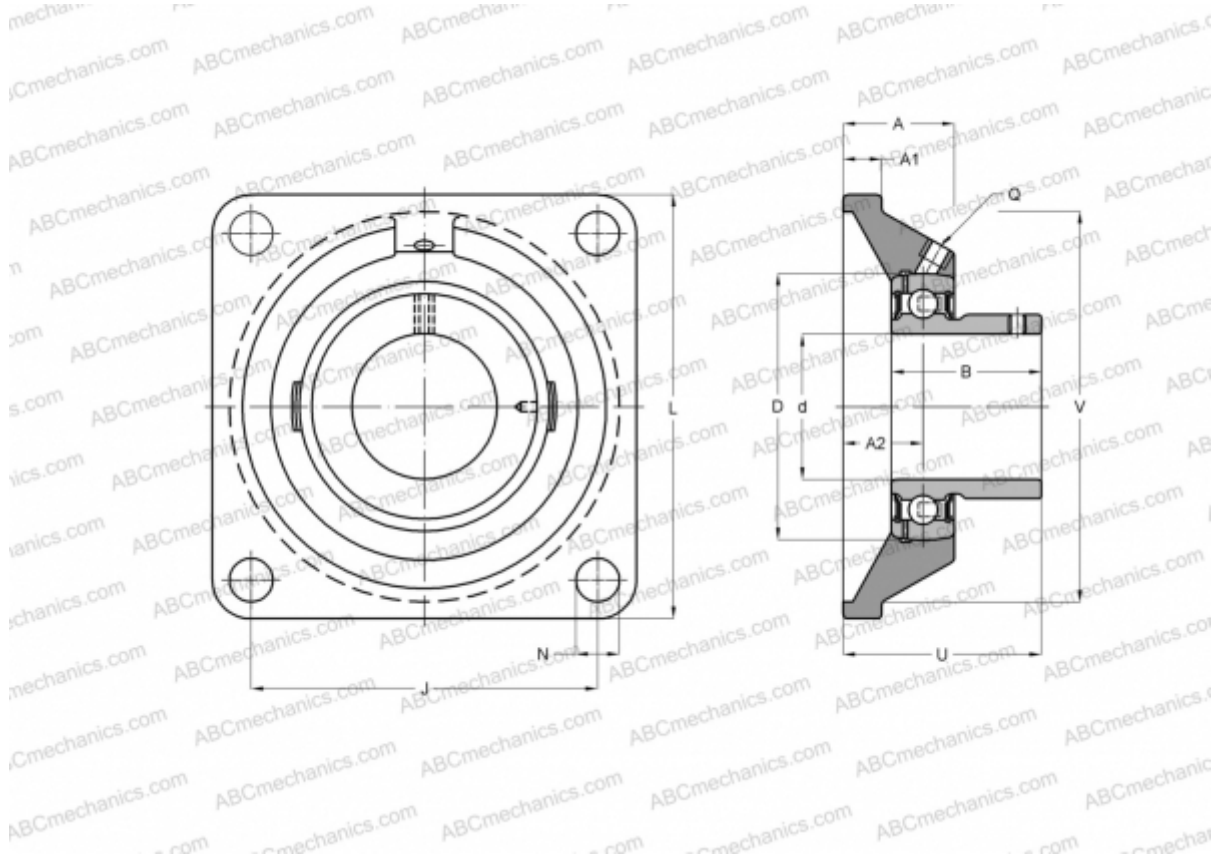

Technical specification

DIMENSIONS, MM

d	65,000
D	140,000
B	75,000
L	208,000
A	40,000
J	166,000
A1	22,000
N	23,000
U	60,000
V	175,000

MANUFACTURER

[ASAHI](#)

WEIGHT, KG

8,600

Bearing	UC 313
Housing	FS 313