

UCFS 317 ASAHI

Ball bearing units

TYPE: Housing units, Four-bolt flanged housing units, Cast iron housing, Radial insert ball bearing with grub screws in inner ring, Type UCFS (ASAHI)

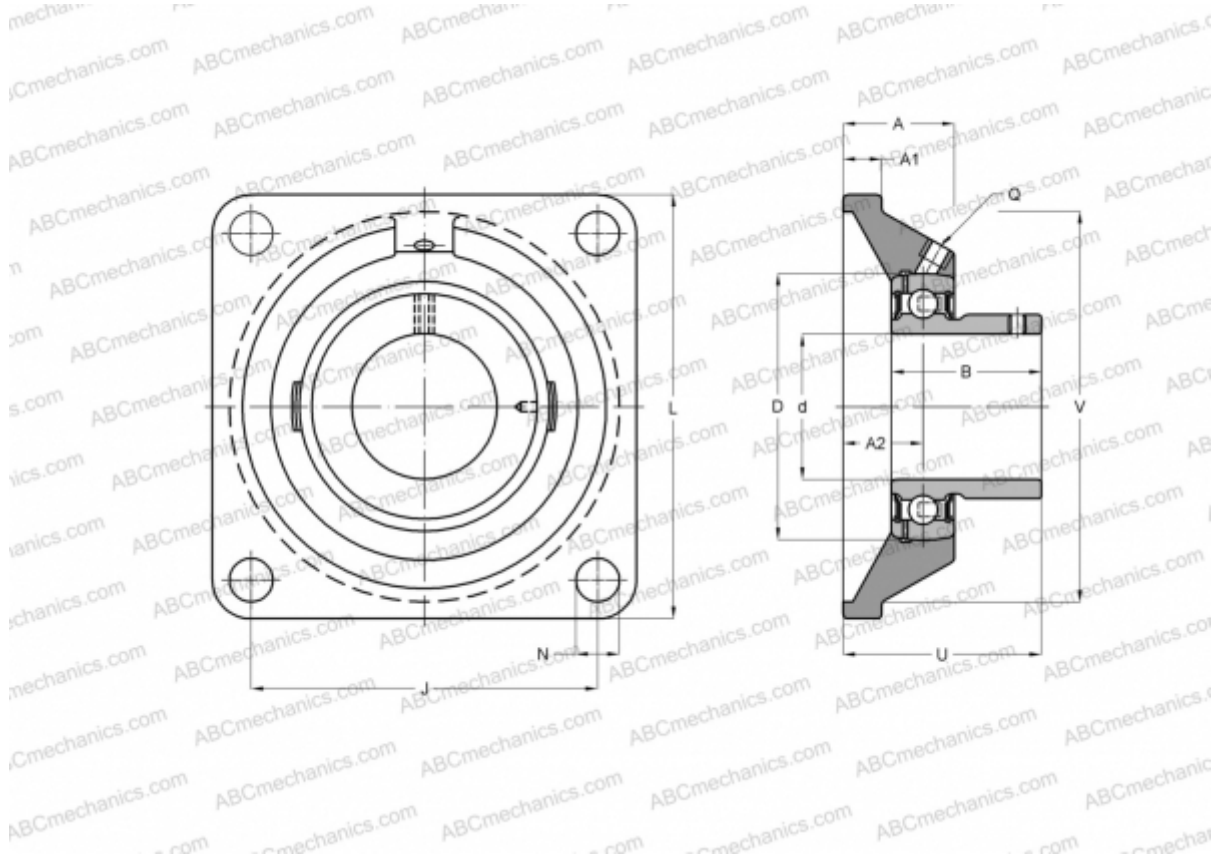

Technical specification

DIMENSIONS, MM

d	85,000
D	180,000
B	96,000
L	260,000
A	54,000
J	204,000
A1	27,000
N	31,000
U	80,000
V	220,000

MANUFACTURER

[ASAHI](#)

WEIGHT, KG

17,200

Bearing	UC 317
Housing	FS 317