

UCFC 201 ASAHI

Ball bearing units

TYPE: Housing units, Four-bolt flanged housing units, Cast iron housing, Radial insert ball bearing with grub screws in inner ring, Type UCFC (ASAHI)

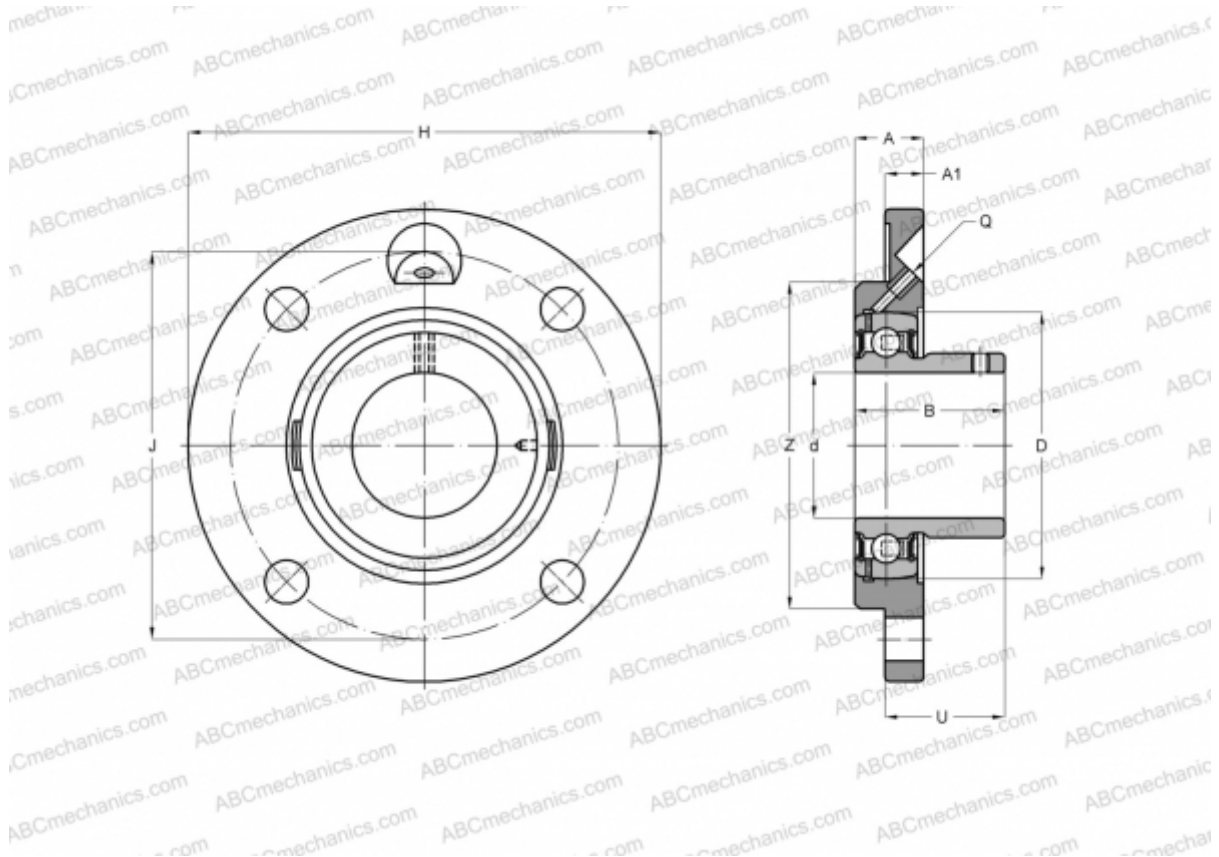

Technical specification

DIMENSIONS, MM

d	12,000
D	47,000
B	31,000
H	100,000
A	20,500
J	78,000
A1	7,000
N	12,000
U	28,300

WEIGHT, KG

	0,890
Bearing	UC 201
Housing	FC 204

MANUFACTURER

[ASAHI](#)