

UCFC 205 ASAHI

Ball bearing units

TYPE: Housing units, Four-bolt flanged housing units, Cast iron housing, Radial insert ball bearing with grub screws in inner ring, Type UCFC (ASAHI)

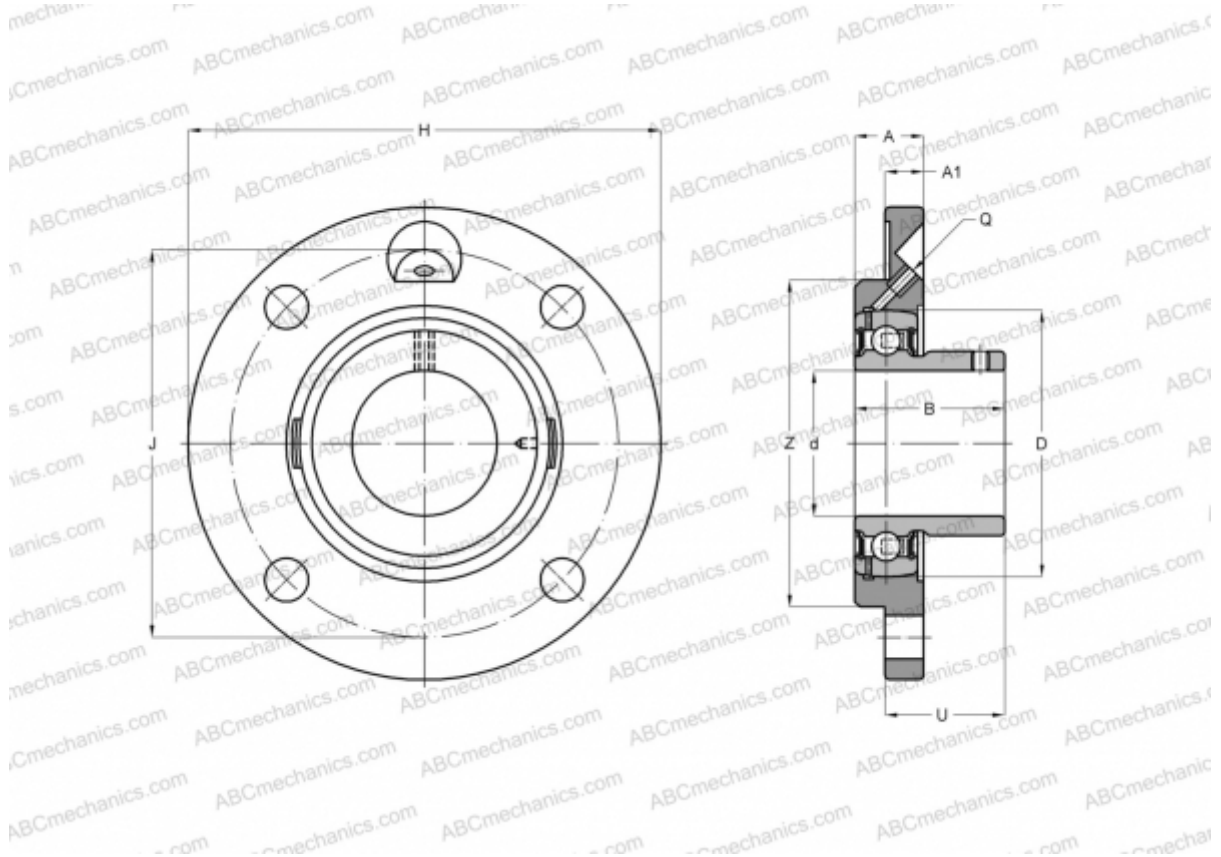

Technical specification

DIMENSIONS, MM

d	25,000
D	52,000
B	34,100
H	115,000
A	21,000
J	90,000
A1	7,000
N	12,000
U	29,700

MANUFACTURER

[ASAHI](#)

WEIGHT, KG

1,100

Bearing	UC 205
Housing	FC 205