

## UCFC 206 ASAHI

Ball bearing units

TYPE: Housing units, Four-bolt flanged housing units, Cast iron housing, Radial insert ball bearing with grub screws in inner ring, Type UCFC (ASAHI)

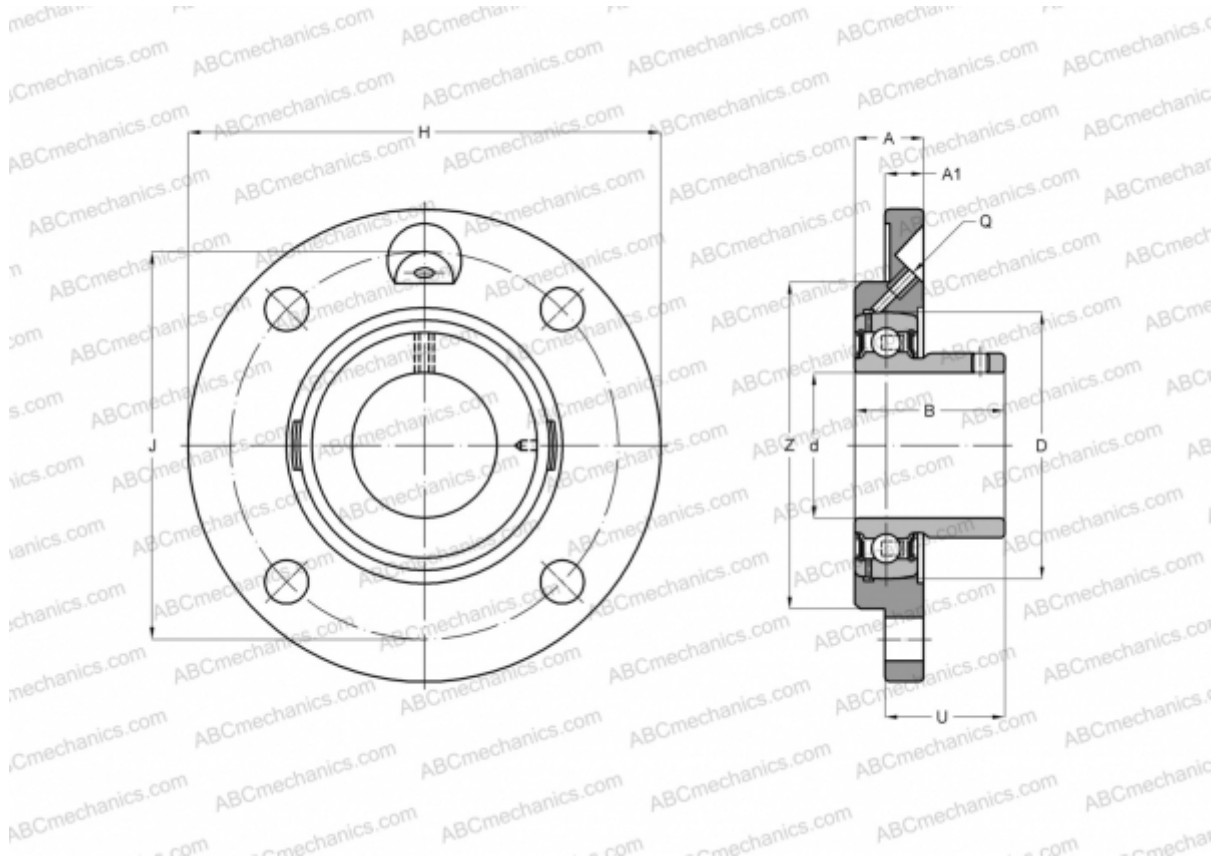

### Technical specification

#### DIMENSIONS, MM

d	30,000
D	62,000
B	38,100
H	125,000
A	23,000
J	100,000
A1	8,000
N	12,000
U	32,200

#### WEIGHT, KG

Bearing	UC 206
Housing	FC 206

#### MANUFACTURER

[ASAHI](#)