

UCFC 207 ASAHI

Ball bearing units

TYPE: Housing units, Four-bolt flanged housing units, Cast iron housing, Radial insert ball bearing with grub screws in inner ring, Type UCFC (ASAHI)

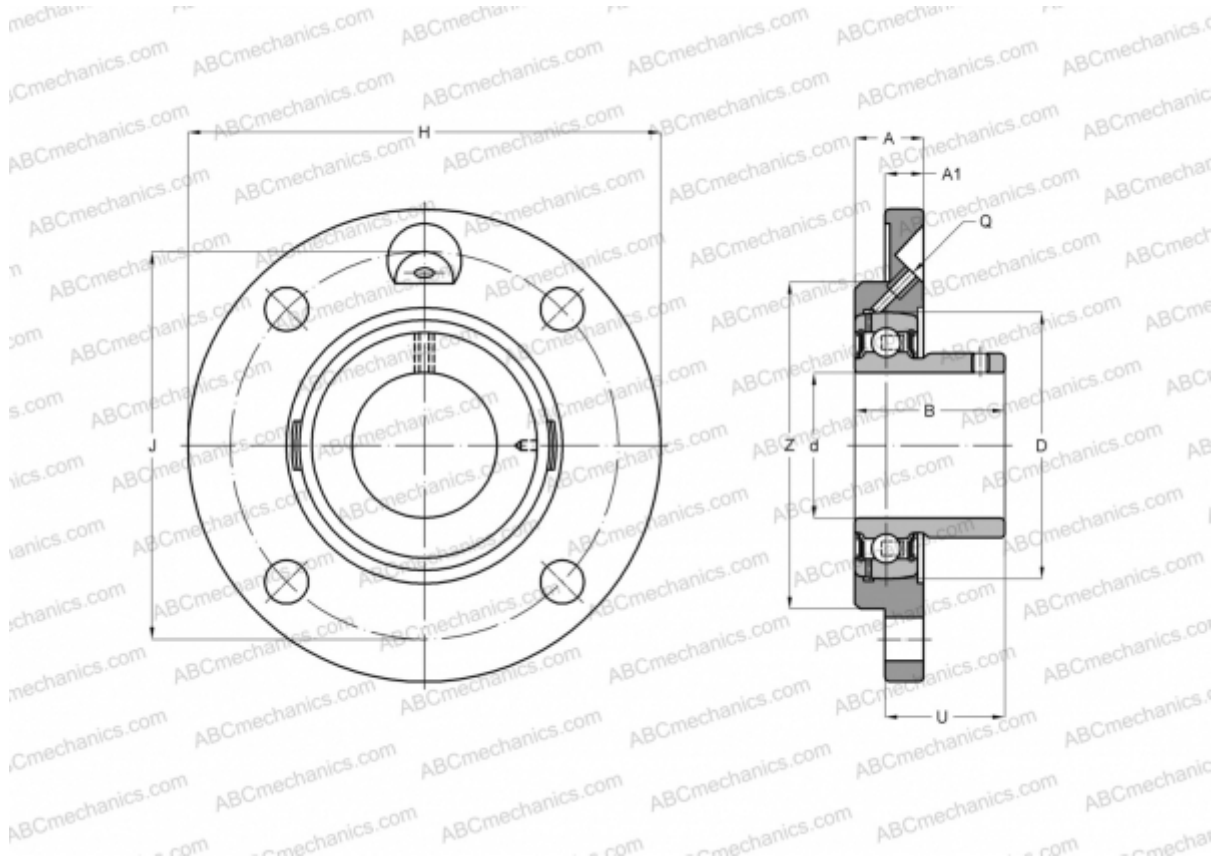

Technical specification

DIMENSIONS, MM

d	35,000
D	72,000
B	42,900
H	135,000
A	26,000
J	110,000
A1	9,000
N	14,000
U	36,400

WEIGHT, KG

Bearing	UC 207
Housing	FC 207

MANUFACTURER

[ASAHI](#)