

UCFC 208 ASAHI

Ball bearing units

TYPE: Housing units, Four-bolt flanged housing units, Cast iron housing, Radial insert ball bearing with grub screws in inner ring, Type UCFC (ASAHI)

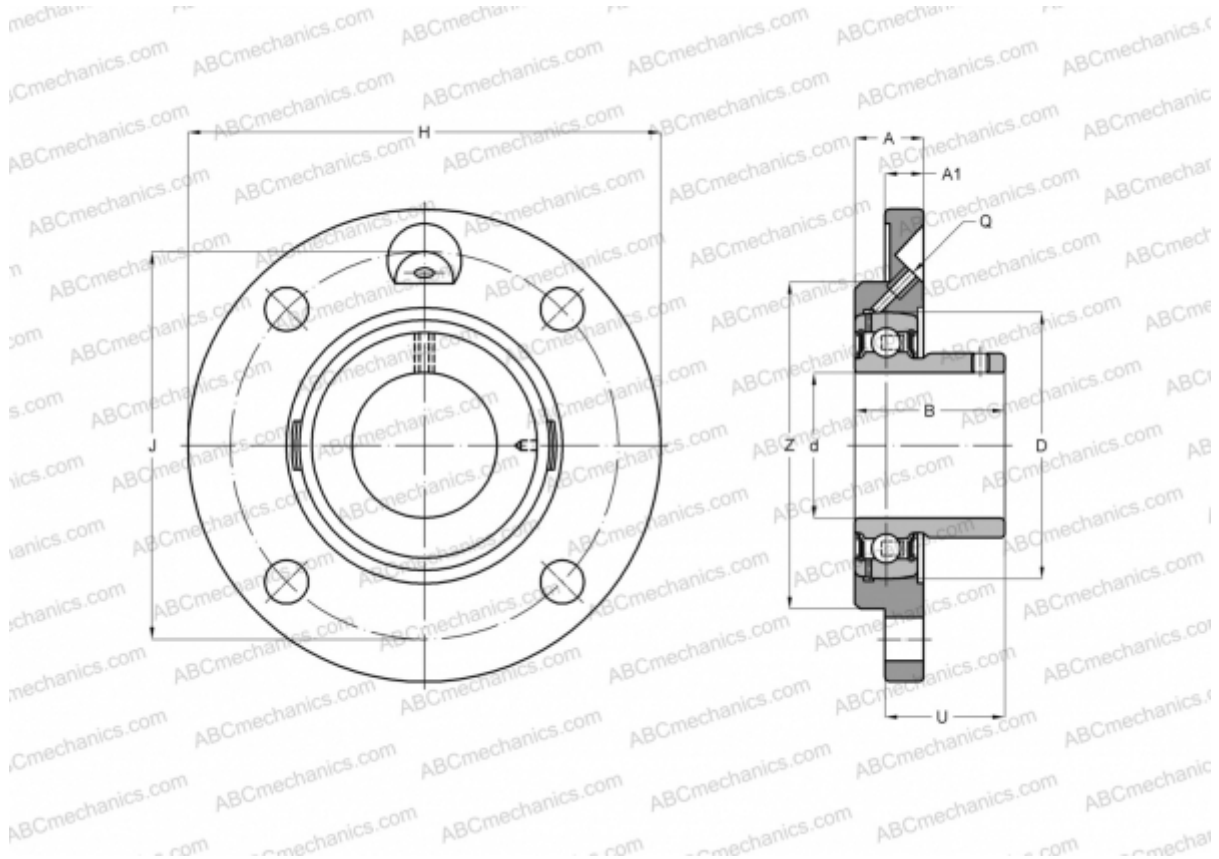

Technical specification

DIMENSIONS, MM

d	40,000
D	80,000
B	49,200
H	145,000
A	26,000
J	120,000
A1	9,000
N	14,000
U	41,200

WEIGHT, KG

Bearing	UC 208
Housing	FC 208

MANUFACTURER

[ASAHI](#)