

UCFC 210 ASAHI

Ball bearing units

TYPE: Housing units, Four-bolt flanged housing units, Cast iron housing, Radial insert ball bearing with grub screws in inner ring, Type UCFC (ASAHI)

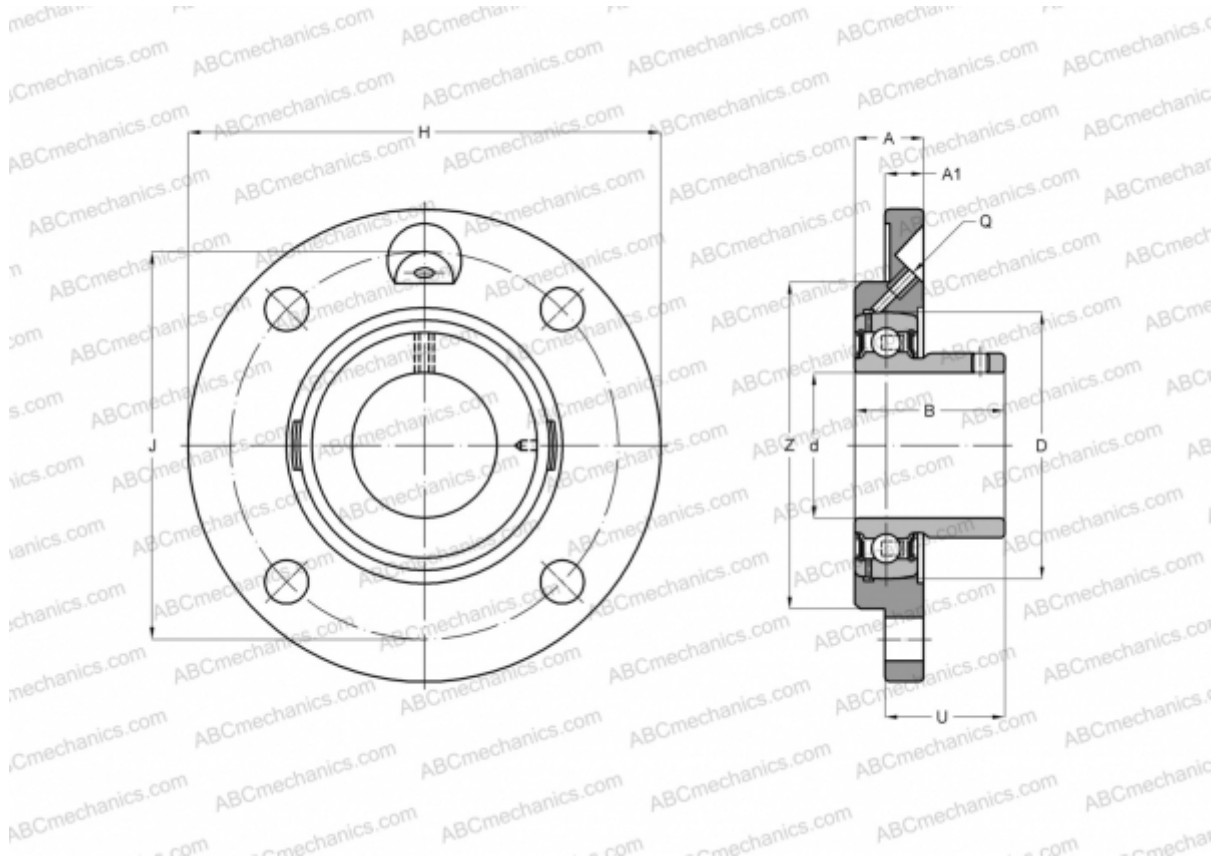

Technical specification

DIMENSIONS, MM

d	50,000
D	90,000
B	51,600
H	165,000
A	28,000
J	138,000
A1	14,000
N	16,000
U	42,600

WEIGHT, KG

	3,100
Bearing	UC 210
Housing	FC 210

MANUFACTURER

[ASAHI](#)