

## UCFC 214 ASAHI

Ball bearing units

TYPE: Housing units, Four-bolt flanged housing units, Cast iron housing, Radial insert ball bearing with grub screws in inner ring, Type UCFC (ASAHI)

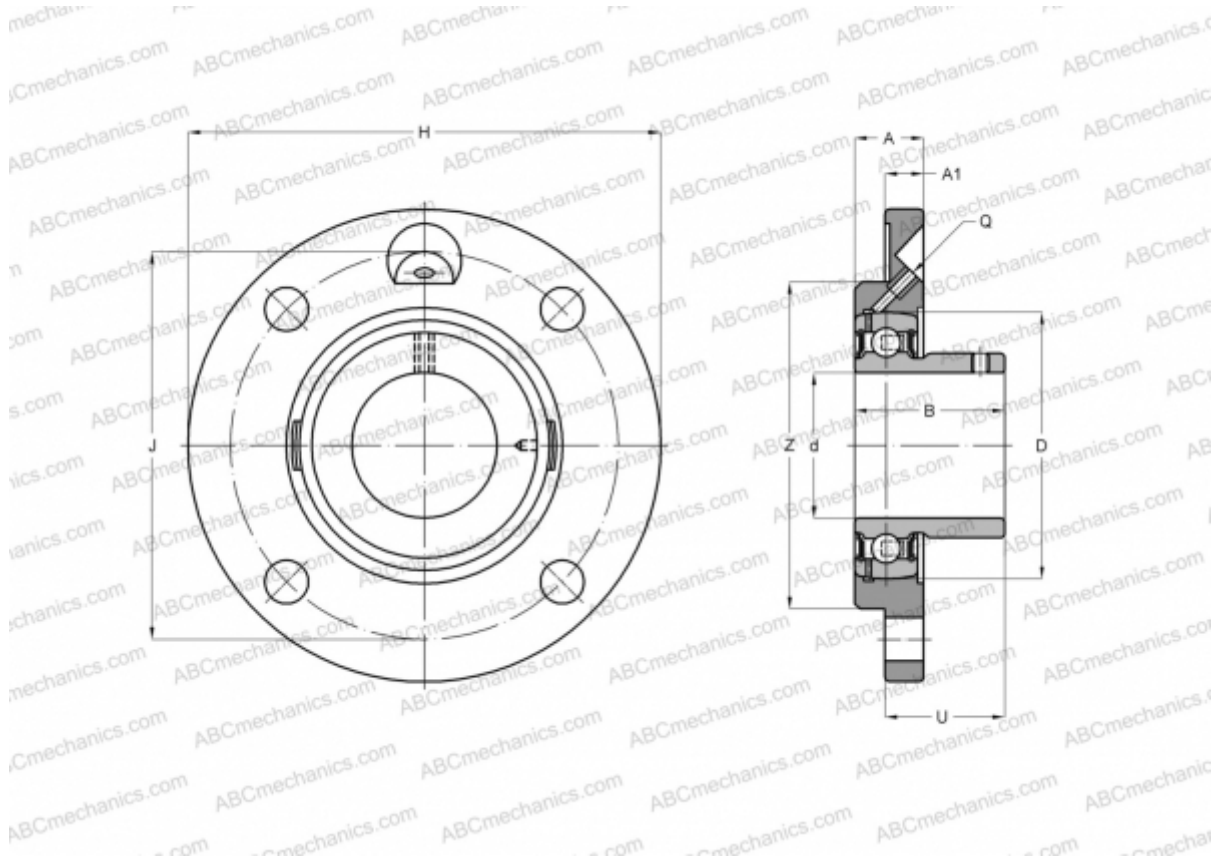

### Technical specification

#### DIMENSIONS, MM

d	70,000
D	125,000
B	74,600
H	215,000
A	40,000
J	177,000
A1	18,000
N	19,000
U	61,400

#### WEIGHT, KG

Bearing	UC 214
Housing	FC 214

#### MANUFACTURER

[ASAHI](#)