

UCFC 216 ASAHI

Ball bearing units

TYPE: Housing units, Four-bolt flanged housing units, Cast iron housing, Radial insert ball bearing with grub screws in inner ring, Type UCFC (ASAHI)

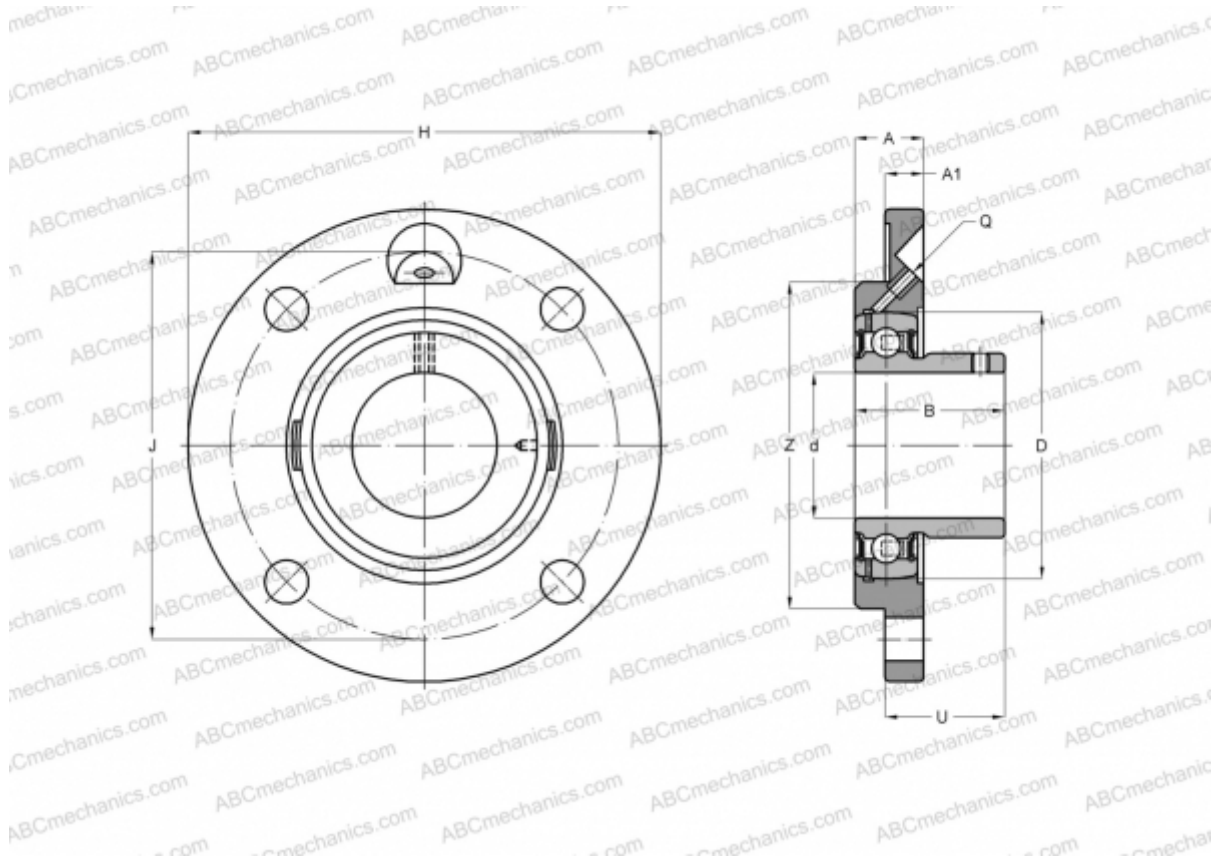

Technical specification

DIMENSIONS, MM

d	80,000
D	140,000
B	82,600
H	240,000
A	42,000
J	200,000
A1	18,000
N	23,000
U	67,300

WEIGHT, KG

Bearing	UC 216
Housing	FC 216

MANUFACTURER

[ASAHI](#)