

UCFC 217 ASAHI

Ball bearing units

TYPE: Housing units, Four-bolt flanged housing units, Cast iron housing, Radial insert ball bearing with grub screws in inner ring, Type UCFC (ASAHI)

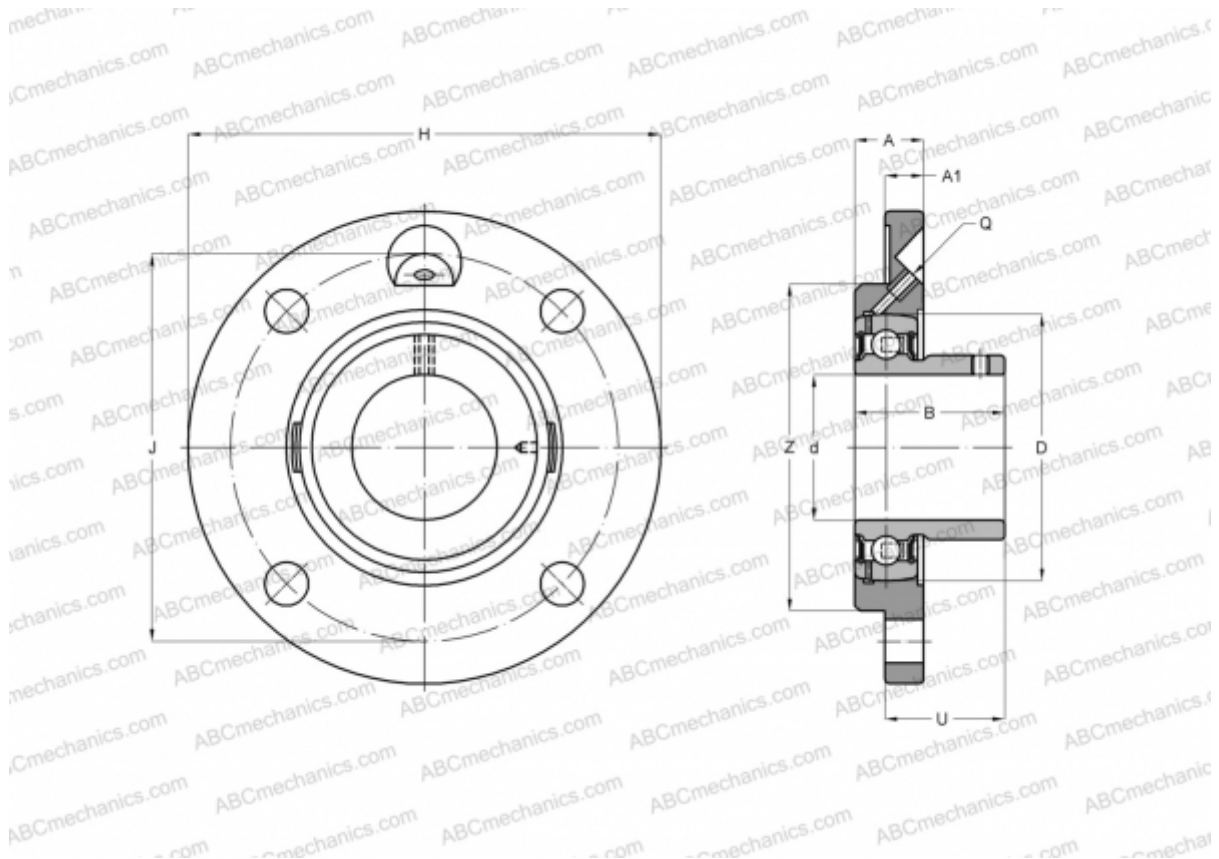

Technical specification

DIMENSIONS, MM

d	85,000
D	150,000
B	85,700
H	250,000
A	45,000
J	208,000
A1	20,000
N	23,000
U	69,600

WEIGHT, KG

Bearing	UC 217
Housing	FC 217

MANUFACTURER

[ASAHI](#)