

UCFC 218 ASAHI

Ball bearing units

TYPE: Housing units, Four-bolt flanged housing units, Cast iron housing, Radial insert ball bearing with grub screws in inner ring, Type UCFC (ASAHI)

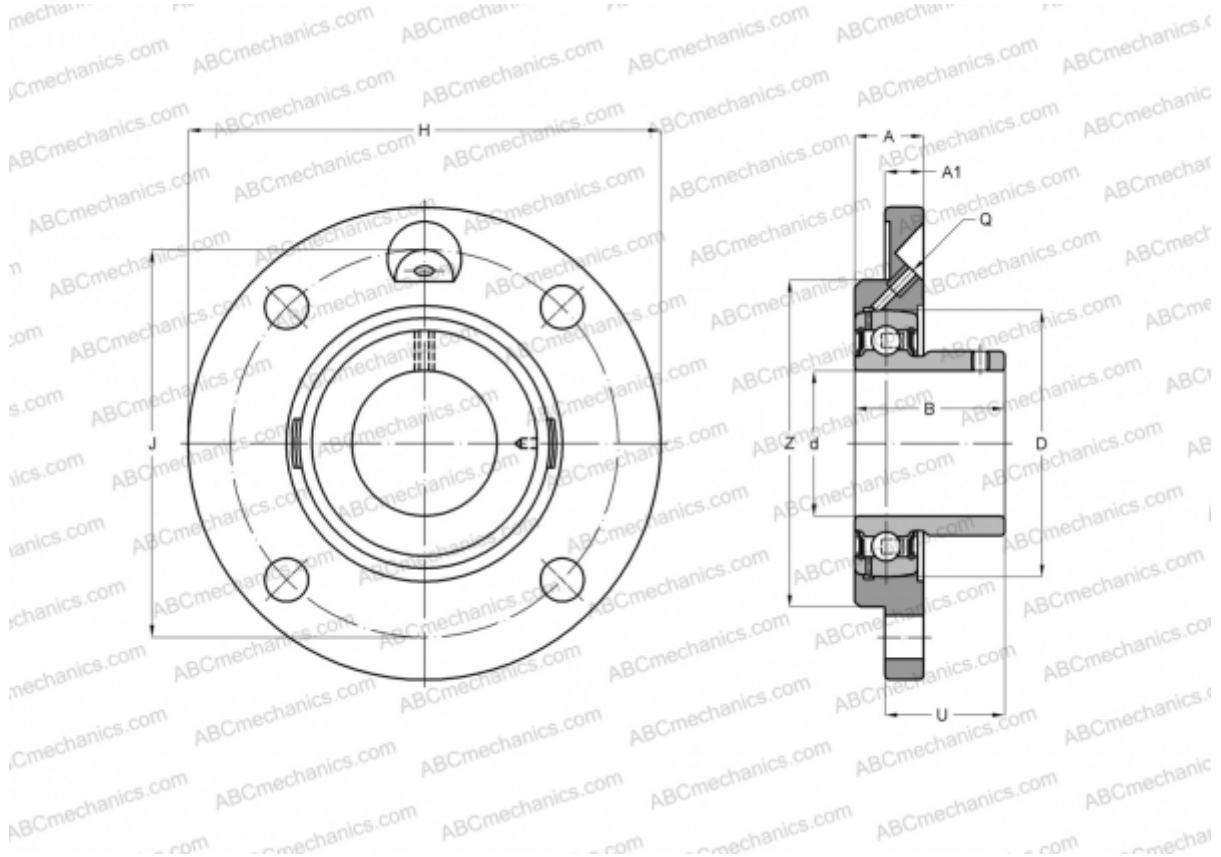

Technical specification

DIMENSIONS, MM

d	90,000
D	160,000
B	96,000
H	265,000
A	50,000
J	220,000
A1	20,000
N	23,000
U	78,300

WEIGHT, KG

Bearing	UC 218
Housing	FC 218

MANUFACTURER

[ASAHI](#)