

UCFC X05 ASAHI

Ball bearing units

TYPE: Housing units, Four-bolt flanged housing units, Cast iron housing, Radial insert ball bearing with grub screws in inner ring, Type UCFCX (ASAHI)

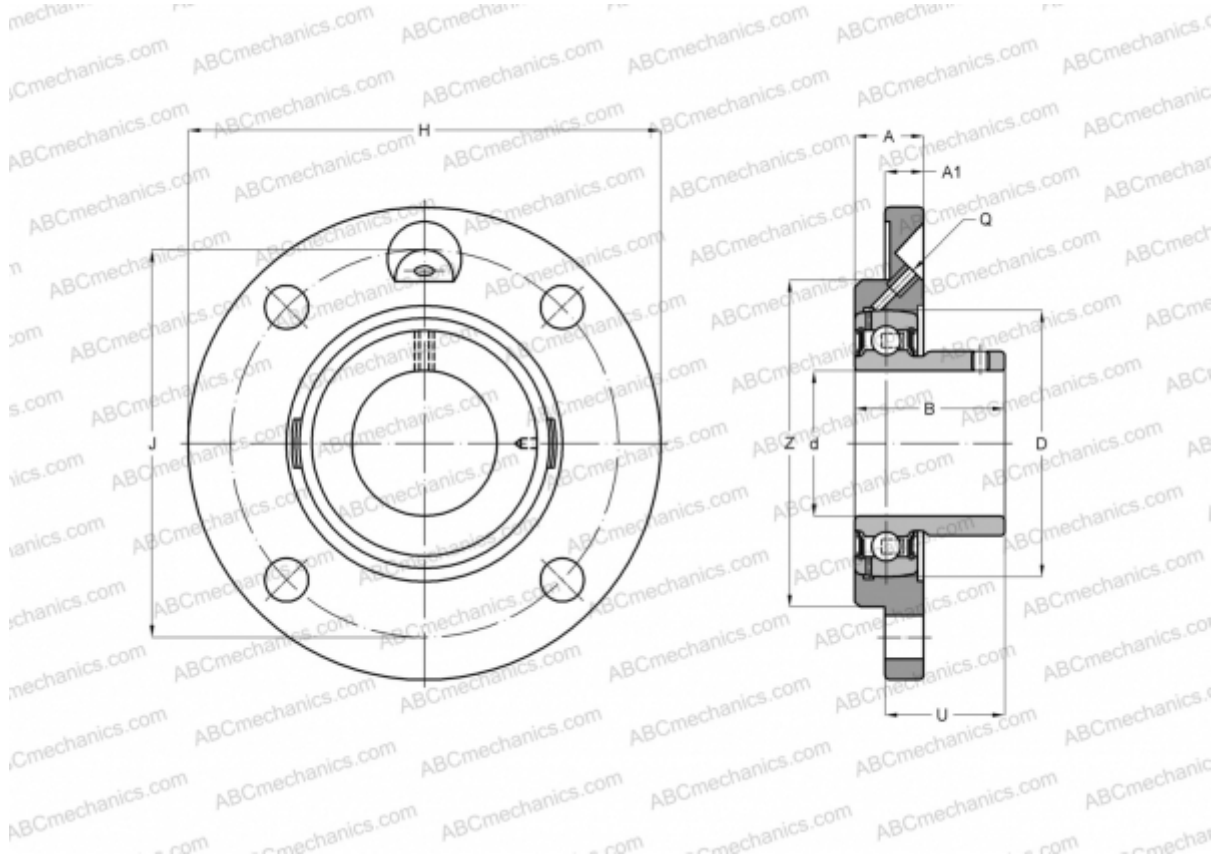

Technical specification

DIMENSIONS, MM

d	25,000
D	62,000
B	38,100
H	111,000
A	24,000
J	92,000
A1	9,500
N	9,500
U	32,200

WEIGHT, KG

1,100

Bearing	UC X05
Housing	FC X05

MANUFACTURER

[ASAHI](#)