

UCFC X08 ASAHI

Ball bearing units

TYPE: Housing units, Four-bolt flanged housing units, Cast iron housing, Radial insert ball bearing with grub screws in inner ring, Type UCFCX (ASAHI)

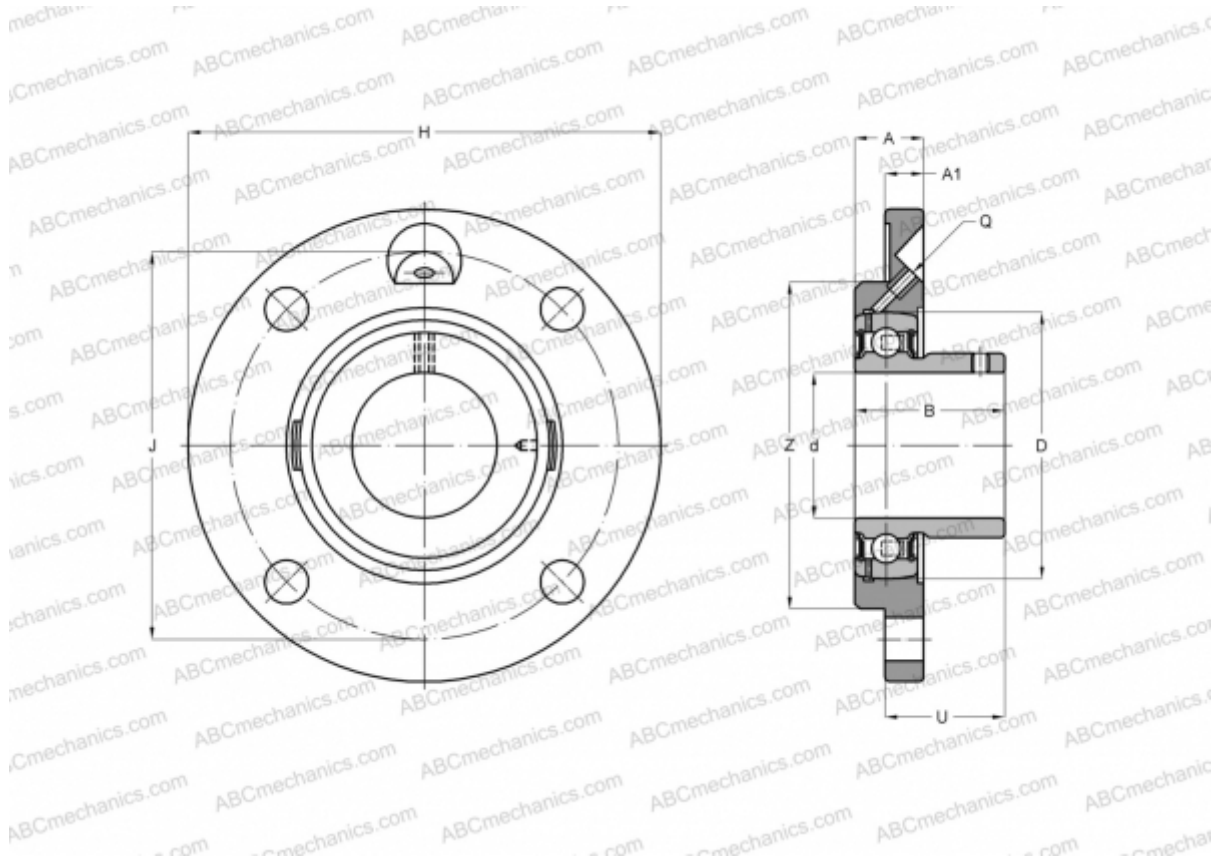

Technical specification

DIMENSIONS, MM

d	40,000
D	85,000
B	49,200
H	133,000
A	26,000
J	111,000
A1	11,000
N	12,000
U	39,200

WEIGHT, KG

1,800

Bearing	UC X08
Housing	FC X08

MANUFACTURER

[ASAHI](#)