

UCFC X09 ASAHI

Ball bearing units

TYPE: Housing units, Four-bolt flanged housing units, Cast iron housing, Radial insert ball bearing with grub screws in inner ring, Type UCFCX (ASAHI)

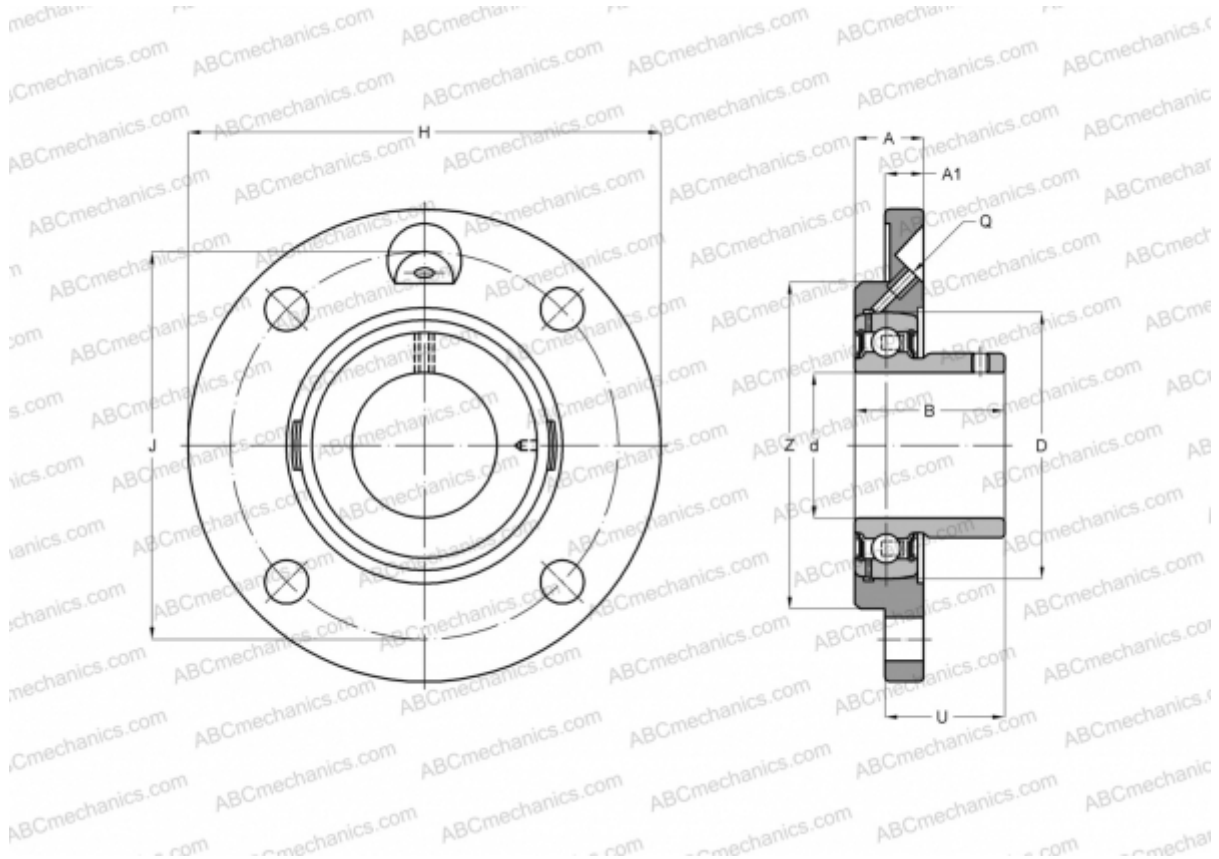

Technical specification

DIMENSIONS, MM

d	45,000
D	90,000
B	51,600
H	155,000
A	25,000
J	130,000
A1	11,000
N	14,000
U	40,600

WEIGHT, KG

2,500

Bearing	UC X09
Housing	FC X09

MANUFACTURER

[ASAHI](#)