

UCFC X10 ASAHI

Ball bearing units

TYPE: Housing units, Four-bolt flanged housing units, Cast iron housing, Radial insert ball bearing with grub screws in inner ring, Type UCFCX (ASAHI)

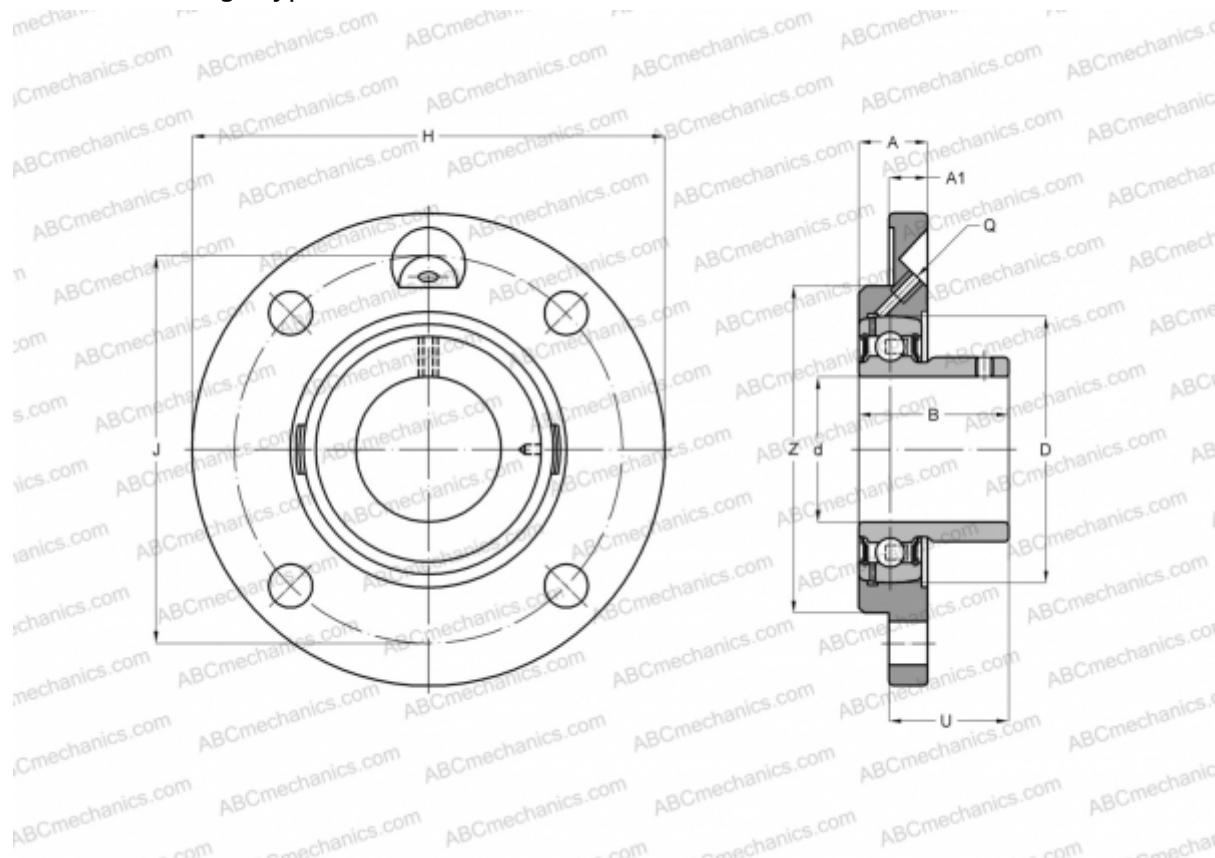

Technical specification

DIMENSIONS, MM

d	50,000
D	100,000
B	55,600
H	162,000
A	25,000
J	136,000
A1	11,000
N	14,000
U	40,400

MANUFACTURER

[ASAHI](#)

WEIGHT, KG

2,900

Bearing	UC X10
Housing	FC X10