

UCFC X11 ASAHI

Ball bearing units

TYPE: Housing units, Four-bolt flanged housing units, Cast iron housing, Radial insert ball bearing with grub screws in inner ring, Type UCFCX (ASAHI)

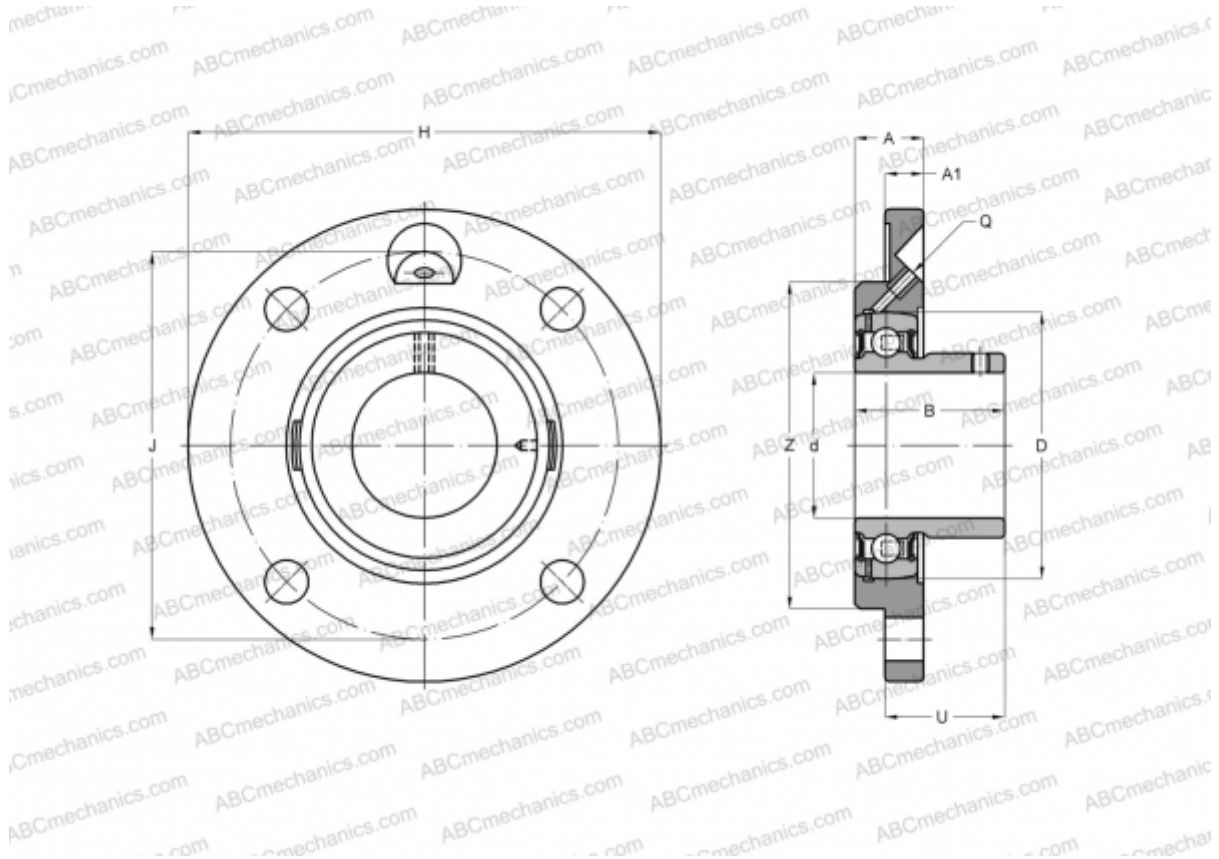

Technical specification

DIMENSIONS, MM

d	55,000
D	110,000
B	65,100
H	180,000
A	26,000
J	152,000
A1	13,000
N	16,000
U	43,700

WEIGHT, KG

4,000

Bearing	UC X11
Housing	FC X11

MANUFACTURER

[ASAHI](#)