

UCFC X12 ASAHI

Ball bearing units

TYPE: Housing units, Four-bolt flanged housing units, Cast iron housing, Radial insert ball bearing with grub screws in inner ring, Type UCFCX (ASAHI)

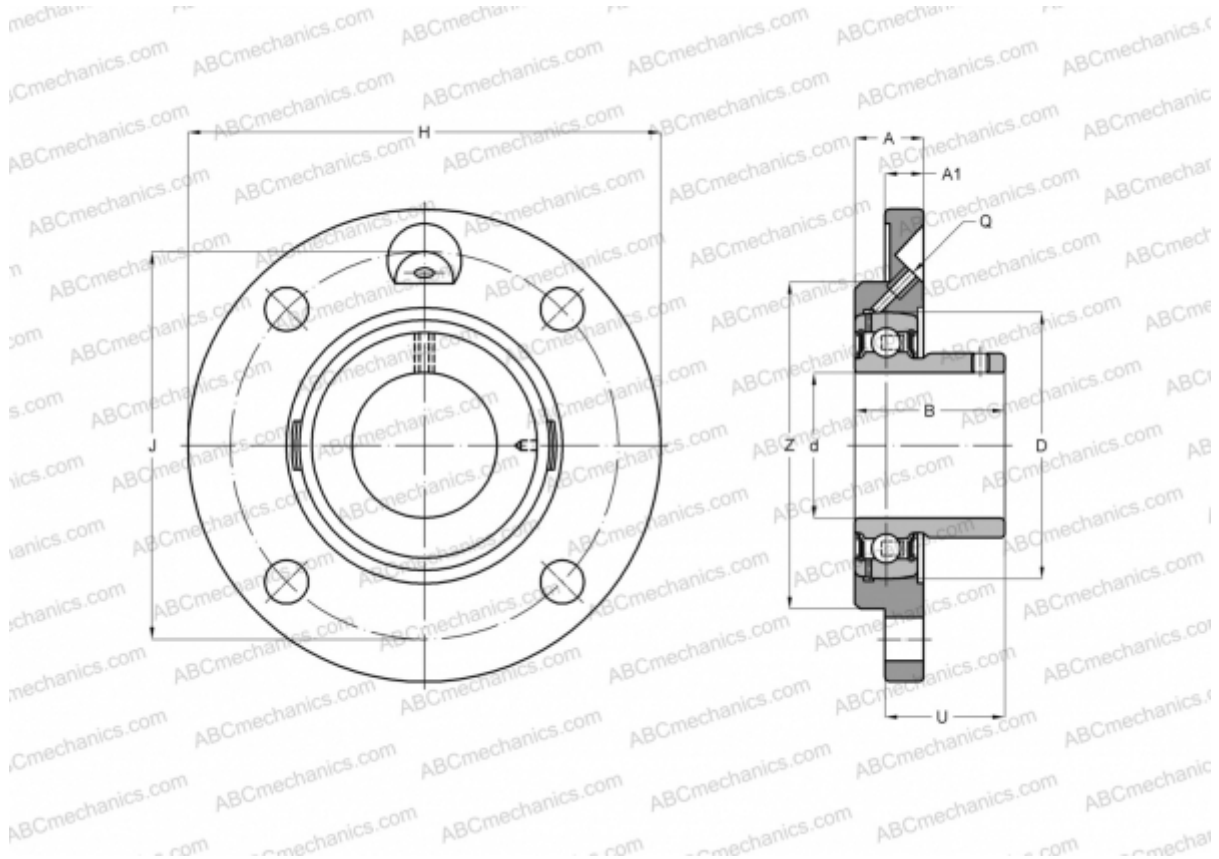

Technical specification

DIMENSIONS, MM

d	60,000
D	120,000
B	75,100
H	194,000
A	33,000
J	165,000
A1	14,000
N	16,000
U	50,700

WEIGHT, KG

4,600

Bearing	UC X12
Housing	FC X12

MANUFACTURER

[ASAHI](#)