

UCFC X13 ASAHI

Ball bearing units

TYPE: Housing units, Four-bolt flanged housing units, Cast iron housing, Radial insert ball bearing with grub screws in inner ring, Type UCFCX (ASAHI)

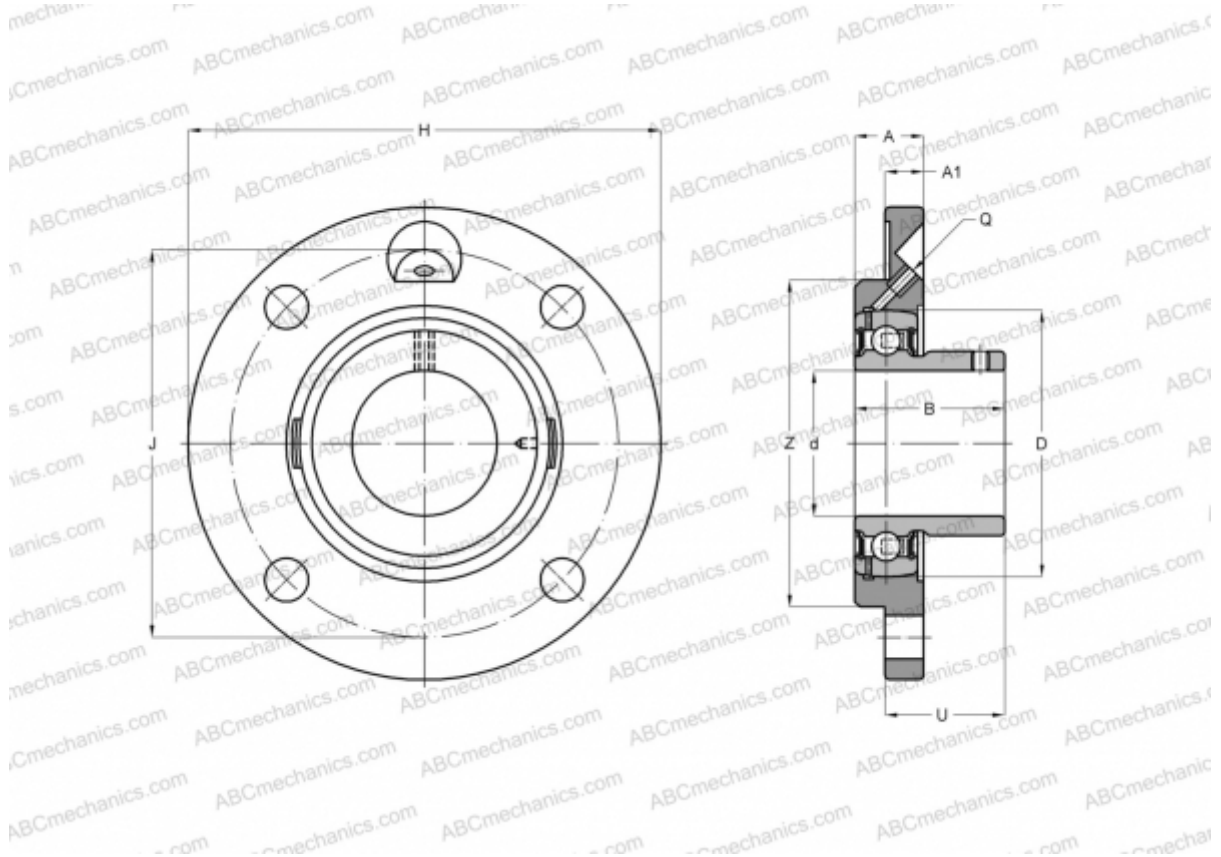

Technical specification

DIMENSIONS, MM

d	65,000
D	125,000
B	74,600
H	194,000
A	33,000
J	165,000
A1	14,000
N	16,000
U	55,400

WEIGHT, KG

4,900

Bearing	UC X13
Housing	FC X13

MANUFACTURER

[ASAHI](#)