

UCFC X15 ASAHI

Ball bearing units

TYPE: Housing units, Four-bolt flanged housing units, Cast iron housing, Radial insert ball bearing with grub screws in inner ring, Type UCFCX (ASAHI)

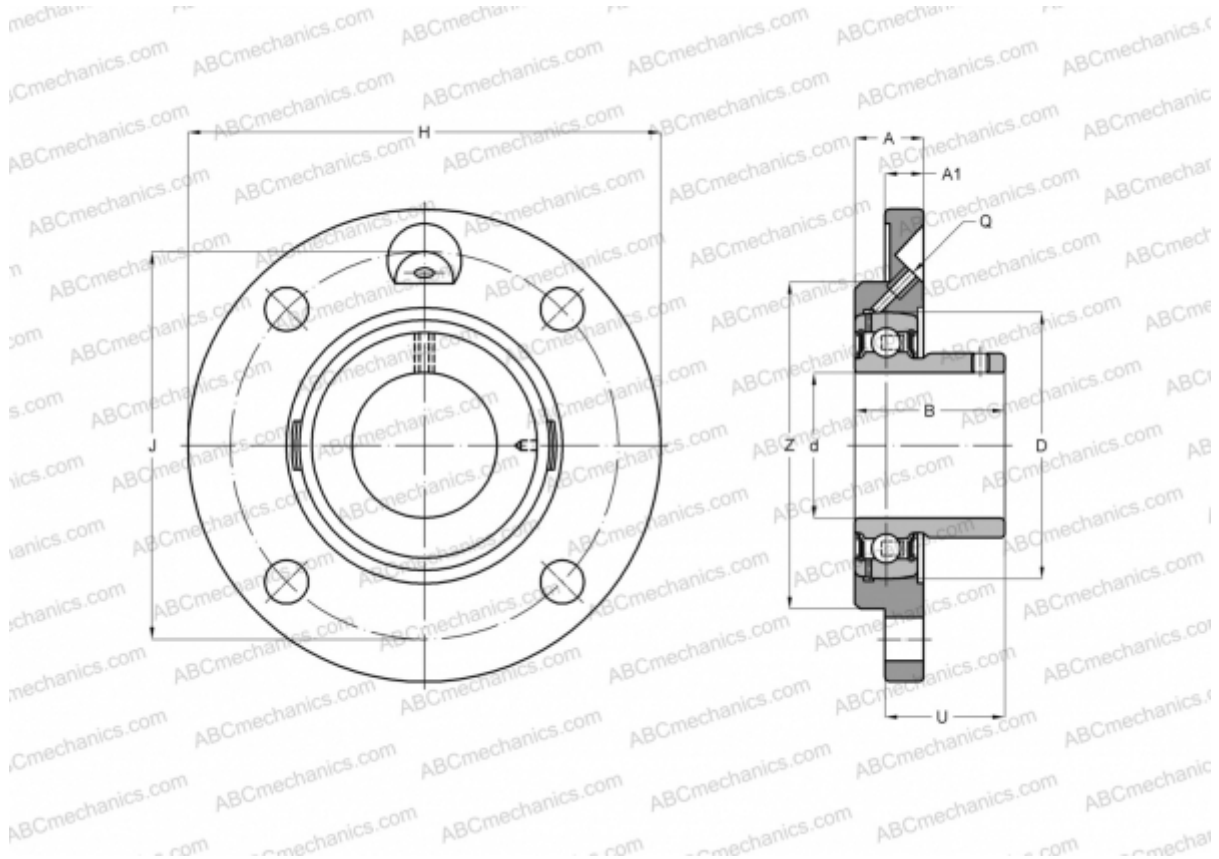

Technical specification

DIMENSIONS, MM

d	75,000
D	140,000
B	82,600
H	222,000
A	35,000
J	190,000
A1	16,000
N	19,000
U	61,300

WEIGHT, KG

7,400

Bearing	UC X15
Housing	FC X15

MANUFACTURER

[ASAHI](#)