

UDT 205 ASAHI

Ball bearing units

TYPE: Housing units, Take-up housing units, Cast iron housing, Radial insert ball bearing with eccentric locking collar, Type UDT (ASAHI)

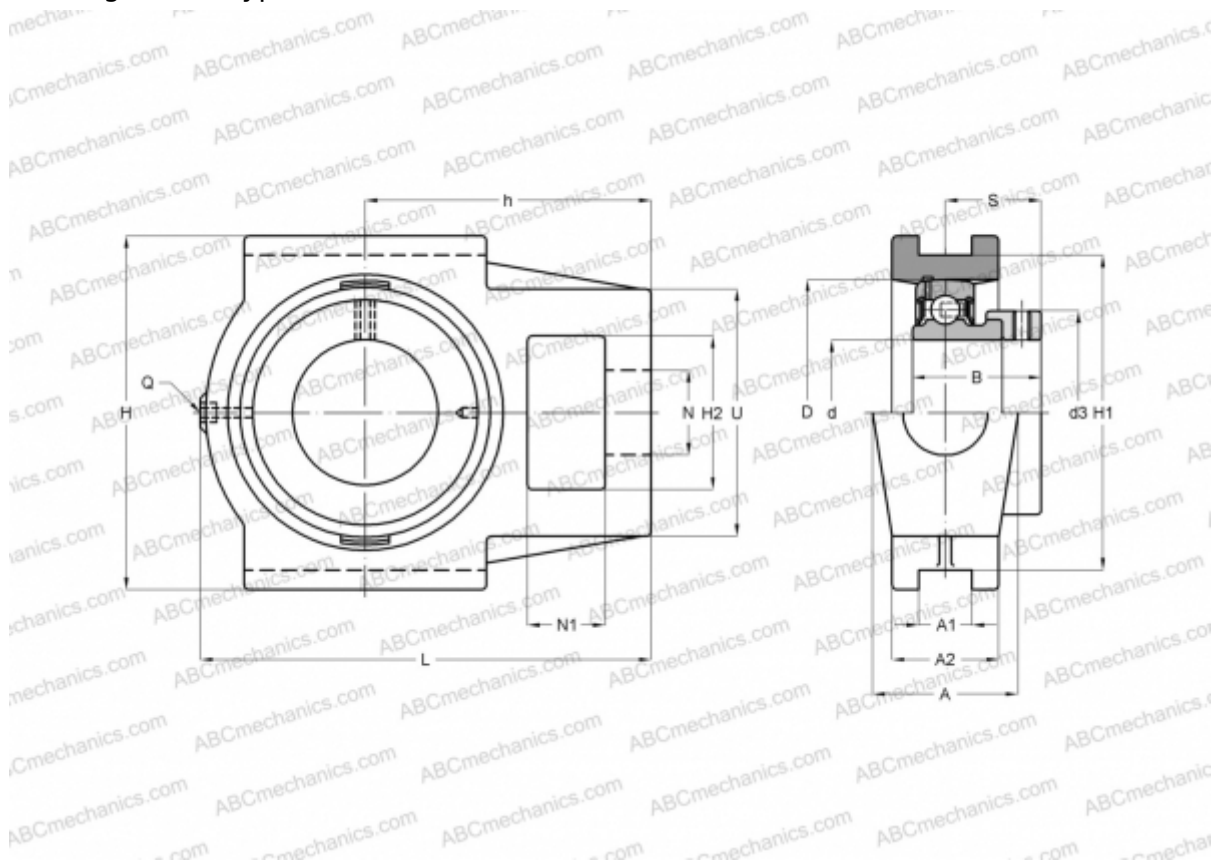

Technical specification

DIMENSIONS, MM

d	25,000
D	52,000
B	32,000
L	97,000
H	89,000
A	32,000
H2	32,000
A1	12,000
A2	24,000
H1	76,000
N	19,000
N1	16,000
d3	34,000
U	51,000
h	62,000

WEIGHT, KG

	0,810
Bearing	UD 205 + EE
Housing	T 205

MANUFACTURER

[ASAHI](#)