

UDT 206 ASAHI

Ball bearing units

TYPE: Housing units, Take-up housing units, Cast iron housing, Radial insert ball bearing with eccentric locking collar, Type UDT (ASAHI)

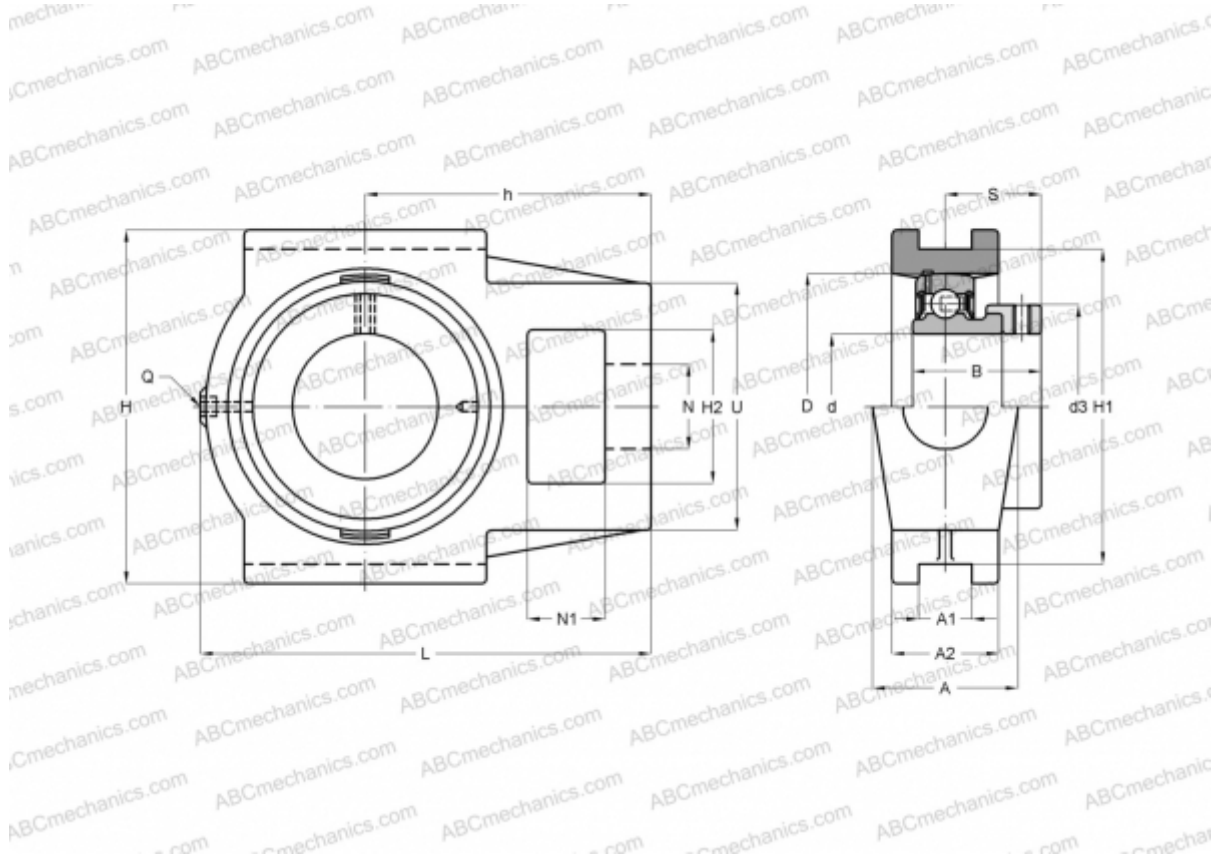

Technical specification

DIMENSIONS, MM

d	30,000
D	62,000
B	36,000
L	113,000
H	102,000
A	37,000
H2	37,000
A1	12,000
A2	28,000
H1	89,000
N	22,000
N1	16,000
d3	40,000
U	56,000
h	70,000

WEIGHT, KG

	1,300
Bearing	UD 206 + EE
Housing	T 206

MANUFACTURER

[ASAHI](#)