

UCT 204 ASAHI

Ball bearing units

TYPE: Housing units, Take-up housing units, Cast iron housing, Radial insert ball bearing with grub screws in inner ring, Type UCT (ASAHI)

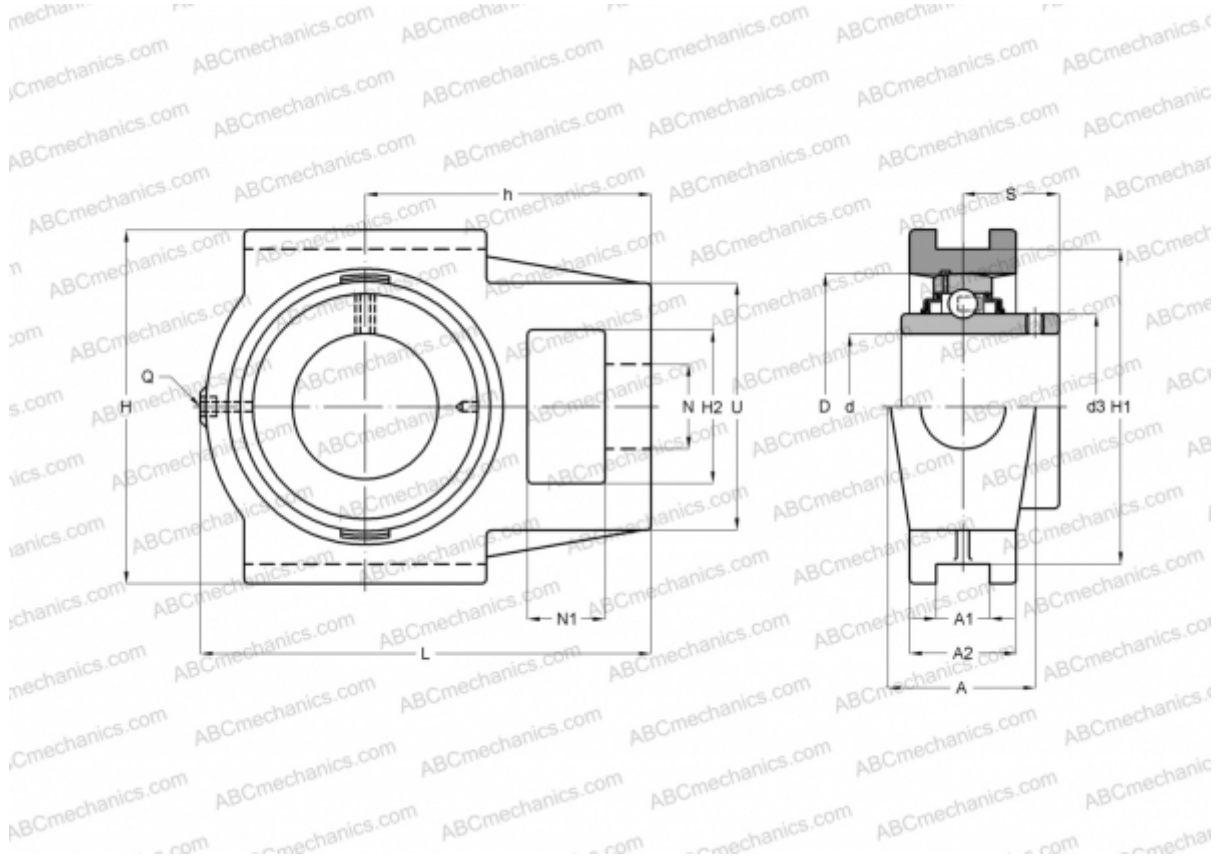

Technical specification

DIMENSIONS, MM

d	20,000
D	47,000
B	31,000
L	94,000
H	89,000
A	32,000
H2	32,000
A1	12,000
A2	21,000
H1	76,000
N	19,000
N1	16,000
S	18,300
d3	29,000
U	51,000

DIMENSIONS, MM

h	61,000
---	--------

WEIGHT, KG

	0,740
Bearing	UC 204
Housing	T 204

MANUFACTURER

[ASAHI](#)