

UCT 211 ASAHI

Ball bearing units

TYPE: Housing units, Take-up housing units, Cast iron housing, Radial insert ball bearing with grub screws in inner ring, Type UCT (ASAHI)

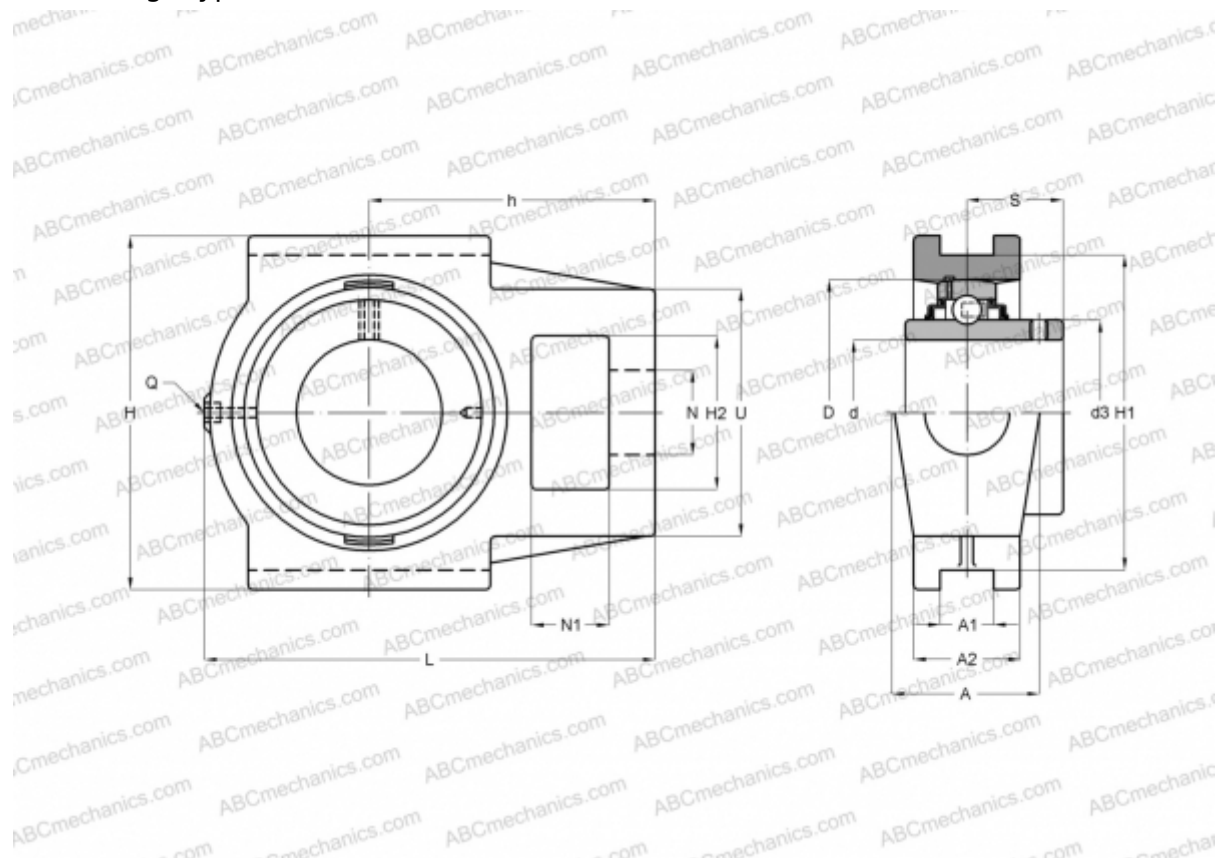

Technical specification

DIMENSIONS, MM

d	55,000
D	100,000
B	55,600
L	171,000
H	146,000
A	64,000
H2	64,000
A1	22,000
A2	38,000
H1	130,000
N	35,000
N1	25,000
S	33,400
d3	70,000
U	102,000

DIMENSIONS, MM

h	106,000
---	---------

WEIGHT, KG

	4,000
Bearing	UC 211
Housing	T 211

MANUFACTURER

[ASAHI](#)