

UCT 214 ASAHI

Ball bearing units

TYPE: Housing units, Take-up housing units, Cast iron housing, Radial insert ball bearing with grub screws in inner ring, Type UCT (ASAHI)

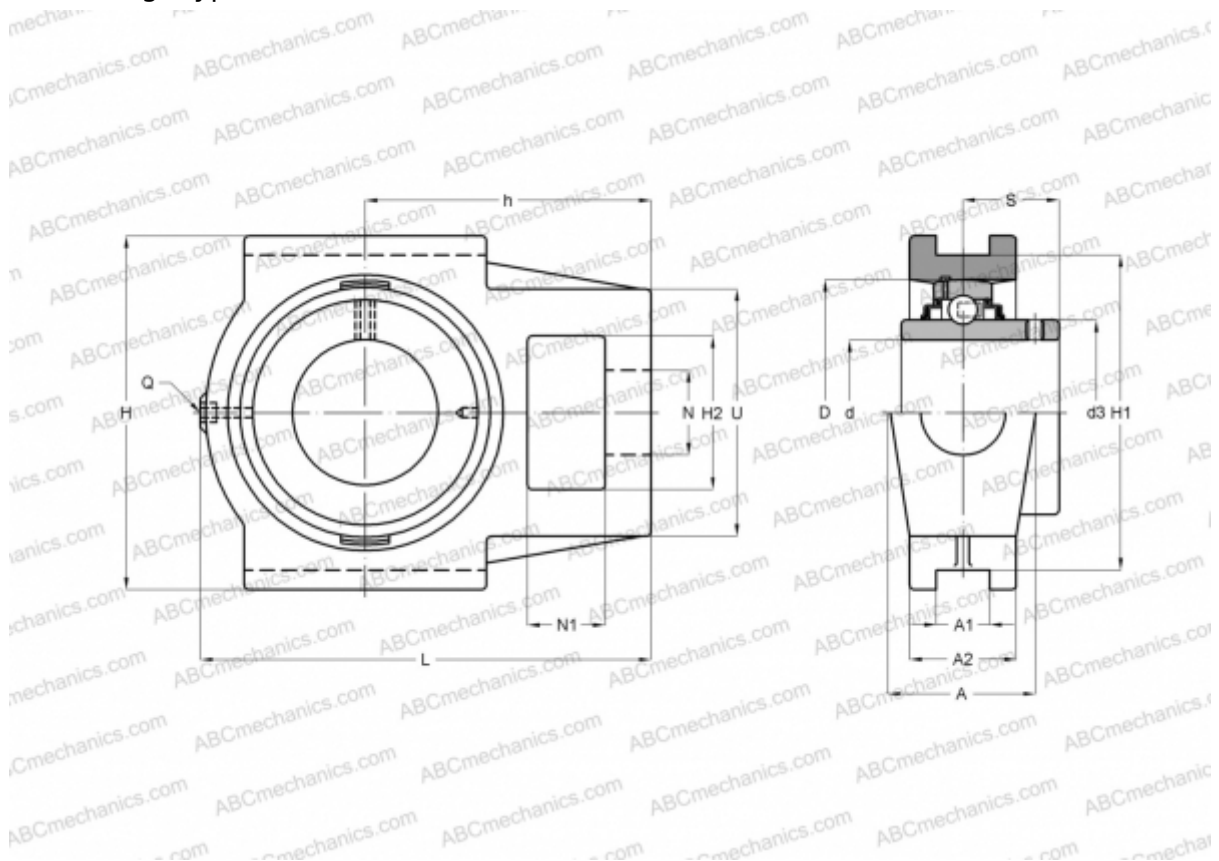

Technical specification

DIMENSIONS, MM

d	70,000
D	125,000
B	74,600
L	224,000
H	167,000
A	70,000
H2	70,000
A1	26,000
A2	46,000
H1	151,000
N	41,000
N1	32,000
S	44,400
d3	87,000
U	111,000

DIMENSIONS, MM

h	137,000
---	---------

WEIGHT, KG

	7,100
Bearing	UC 214
Housing	T 214

MANUFACTURER

[ASAHI](#)